

Slant/Fin[®]

MODEL EM-10 MONITRON II **ELECTRIC BOILER CONTROL**

SERVICE MANUAL

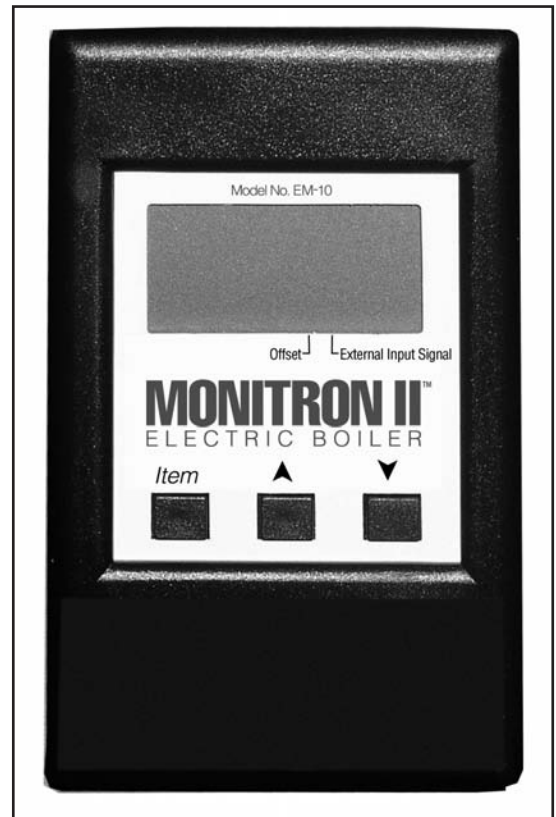

How to Use the Data Brochure

This brochure is organized into three main sections. They are: 1) Sequence of Operation, 2) Installation, and 3) Control Settings.

The Control Settings section of this brochure describes the various items that are adjusted and displayed by the control. The control functions of each adjustable item are described in the Sequence of Operation.

Table of Contents

User Interface	2
Display and Symbol Description	3
Sequence of Operation	4
Section A: General	4
Section B: Setpoint Operation	9
Section C: Dedicated DHW Operation	9
Section D: Outdoor Reset Operation	10
Section E: External Temperature Target Input	10
Section F: External Direct Drive Operation	11
Installation	12
Testing	13
Control Settings	15
DIP Switch Settings	15
Mode 1 and 2 - Two Setpoint Operation	16
View Menu	16
Adjust Menu	17

Mode 3 - Dedicated DHW with Parallel Piping	19
View Menu	19
Adjust Menu	20
Mode 4 and 5 - Outdoor Reset / Setpoint Operation	22
View Menu	23
Default Settings	24-26
Adjust Menu	24
Mode 6 and 7 - External Target / Setpoint Operation	27
View Menu	28
Adjust Menu	29
Mode 8 - External Direct Drive Operation	31
View Menu	31
Adjust Menu	32
Error Messages	33
Reload Factory Defaults	34
Specifications	36

User Interface

The BTC uses a Liquid Crystal Display (LCD) as a method of supplying information. You use the LCD in order to setup and monitor the operation of your system. The BTC uses three push buttons (Item, ▲, ▼) for selecting and adjusting settings. As you program your control, record your settings in the settings column of the Adjust menu. The table is found in the second half of this brochure.

MENU

All of the items displayed by the control are organized into two menus:

- 1) View
- 2) Adjust

These menus are listed on the upper right hand side of the display (Menu Field). The default menu for the BTC is the View menu. While in the View menu, the VIEW segment is displayed.

To select the Adjust menu, press and hold simultaneously all three buttons (Item, ▲, ▼) for 1 second.



The display then advances to the Adjust menu and the ADJUST segment is turned on in the display. The display will automatically revert back to the View menu after 20 seconds of keypad inactivity. Once in a menu, there will be a group of items that can be viewed within that menu.

ITEM

The abbreviated name of the selected item will be displayed in the item field of the display.

To view the next available item, press and release the Item button.

Once you have reached the last available item in a menu, pressing and releasing the Item button will return the display to the first item in the selected menu.



ADJUST

To make an adjustment to a setting in the control, begin by selecting the Adjust menu by pressing and holding simultaneously all three buttons.

Then select the desired item using the Item button. Finally, use the ▲ or ▼ button to make the adjustment.





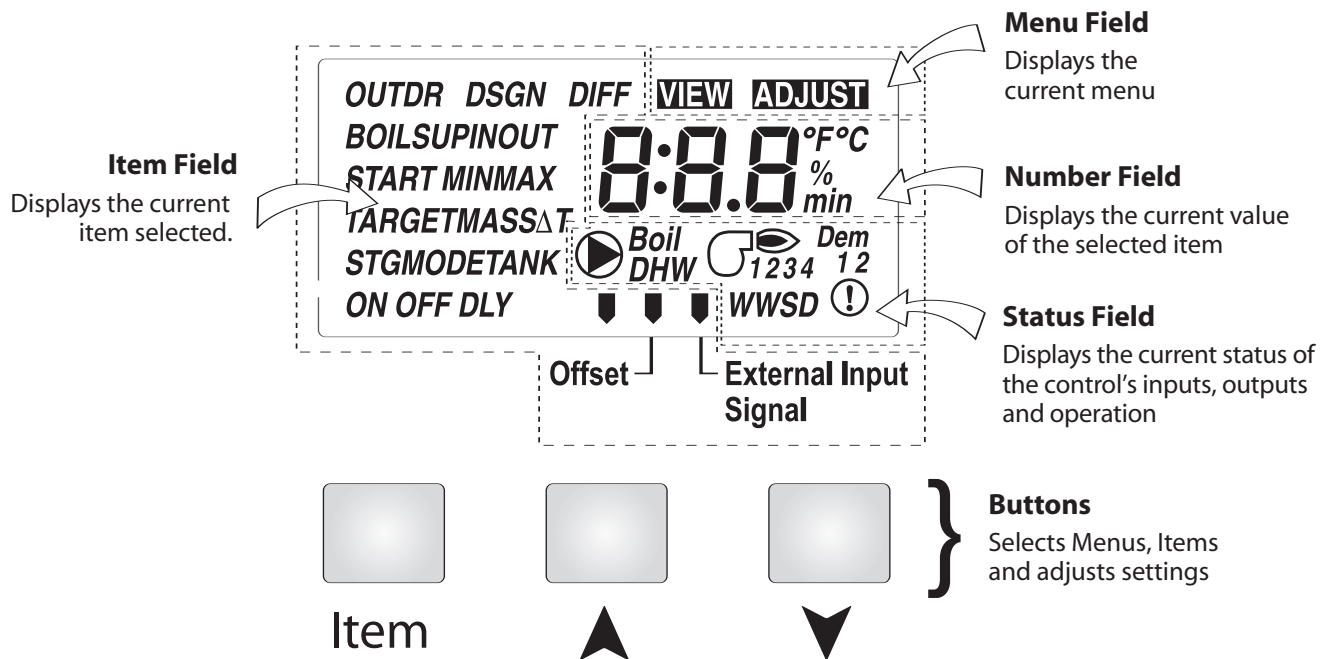

STATUS FIELD

Additional information can be gained by observing the Status field of the LCD. The status field will indicate which of the control's outputs are currently active. Symbols in the status field are only visible when the View menu is selected.

Display



Symbol Description

 Boil	BOILER PUMP Displays when the boiler pump is in operation.	Dem₂	DEMAND 2 Displays when a call for heat on demand 2 is present.
	BURNER Displays when stage 1, 2, 3, or 4 contact is on.		ERROR Displays when an error message is present.
WWSD	WWSD Displays when the control is in Warm Weather Shut Down.		POINTERS Displays operation as indicated by the text.
Dem₁	DEMAND 1 Displays when a call for heat on demand 1 is present.	°F, °C	°F or °C Displays the temperature units.

Section A: General

POWERING UP THE CONTROL

When the control is powered up, the control turns on all segments in the display for 2 seconds. Next, the software version is displayed for 2 seconds. Last, the control enters into the normal operating mode.

DISPLAY BACKLIGHT

The control's display has a backlight that is permanently on while the control is powered.

PIPING

The boiler can be piped in parallel or in primary/secondary to the system. The type of piping chosen affects the location of the control's operating temperature sensor. The control can either use the boiler outlet sensor or the boiler supply sensor.

PARALLEL PIPING

In parallel piping applications, the boiler outlet temperature is typically the same as that delivered to the system. Therefore the operating temperature sensor is the boiler outlet sensor.

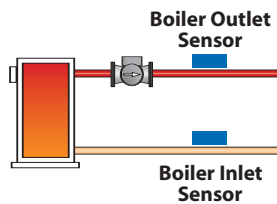

PRIMARY/SECONDARY PIPING

In primary/secondary applications, the boiler outlet temperature (primary loop) is typically hotter than the system supply temperature (secondary loop). This occurs when the system supply pipe has a larger flow rate than the boiler outlet pipe. Therefore, the control requires an additional sensor (boiler supply) to measure the temperature delivered out to the system. The operating temperature sensor is the boiler supply sensor.

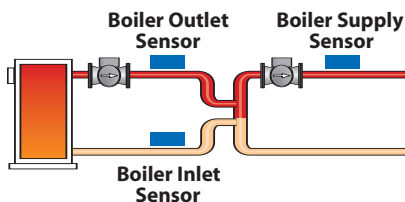

MODES OF OPERATION (MODE)

The control allows for seven modes of operation in order to define the control operation and piping arrangement used. The piping arrangement can be categorized into parallel and primary / secondary. The mode of operation is selected using the MODE item in the Adjust menu. The temperature being controlled out to the heating system is measured by the operating sensor.

The piping arrangement determines which sensor the control uses as the operating sensor. The operating sensor is either the boiler outlet sensor or the boiler supply sensor.

MODE 1 (Two Setpoints with Parallel Piping)

Mode 1 is designed for setpoint operation using parallel piping. The heat demand is available to activate a setpoint for space heating systems. The setpoint demand is available to activate a second setpoint for heating an indirect domestic hot water tank.

Once a heat demand is present, the control stages the boiler to maintain the boiler target 1 at the boiler outlet sensor. Once a setpoint demand is present, the control stages the boiler to maintain the boiler target 2 at the boiler outlet sensor. If both demands are present, the control operates at the higher of the two targets. Refer to section B for a description of setpoint operation.

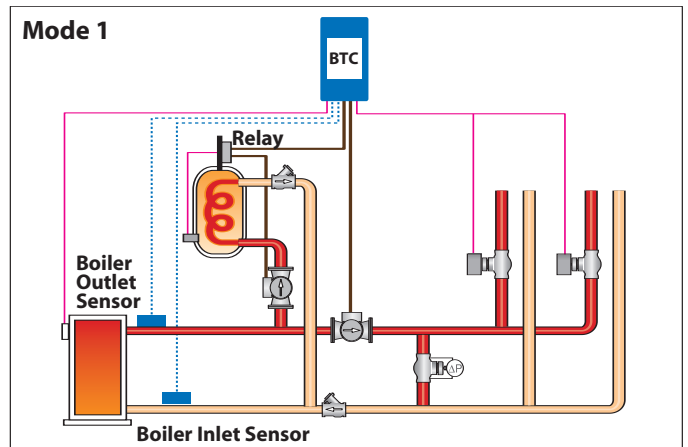

MODE 2 (Two Setpoints with Primary/Secondary Piping)

Mode 2 is designed for setpoint operation using primary / secondary piping. A heat demand is available to activate a setpoint for space heating systems. A setpoint demand is available to activate a second setpoint for heating an indirect domestic hot water tank.

Once a heat demand is present, the control stages the boiler to maintain the boiler target 1 at the boiler supply sensor. Once a setpoint demand is present, the control stages the boiler to maintain the boiler target 2 at the boiler supply sensor. If both demands are present, the control operates at the higher of the two targets. Refer to section B for a description of setpoint operation.

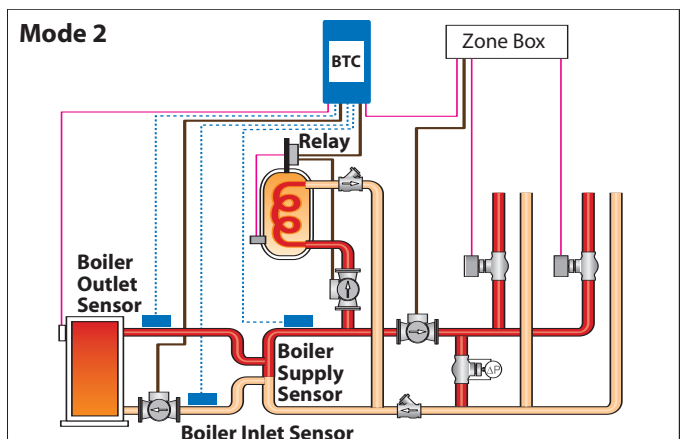

MODE 3

(Dedicated Domestic Hot Water Tank)

Mode 3 is designed for heating a dedicated domestic hot water tank using parallel piping. A tank sensor creates an internal heat demand in the control. Once an internal heat demand is present, the control stages the boiler to maintain the boiler target temperature at the boiler outlet sensor. Refer to section C for a description of dedicated domestic hot water tank operation.

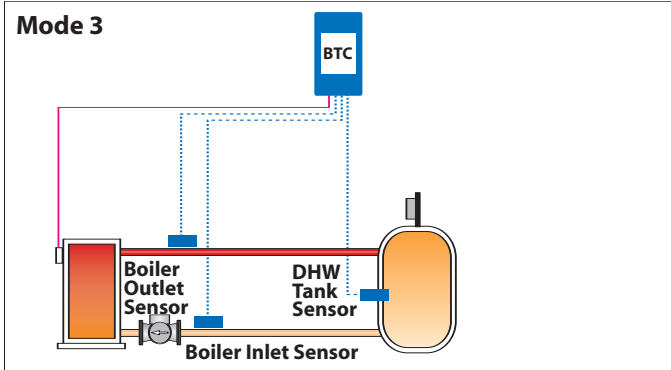

MODE 4

(Outdoor Reset and Setpoint with Parallel Piping)

Mode 4 is designed for outdoor reset and setpoint operation using parallel piping. The heat demand is available to provide outdoor reset for space heating systems. The setpoint can be used to heat an indirect domestic hot water tank.

Once a heat demand is present, the control stages the boiler to maintain the calculated outdoor reset target at the boiler outlet sensor. Refer to section D for a description of outdoor reset operation.

Once a setpoint demand is present, the control stages the boiler to maintain the boiler target at the boiler outlet sensor. If both demands are present at the same time, the control targets the higher of the two requirements. Refer to section B for a description of setpoint operation.

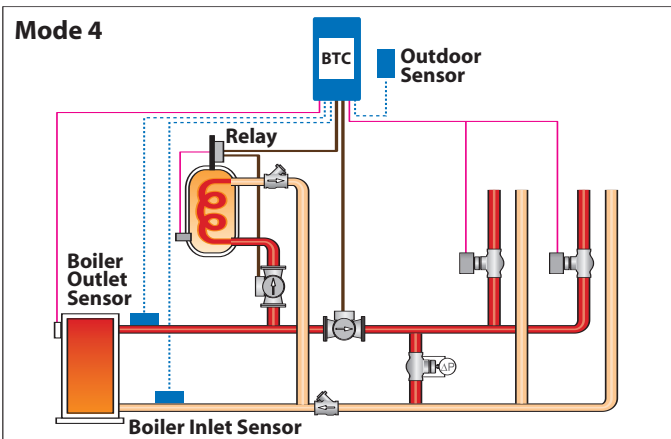

MODE 5 (Outdoor Reset and Setpoint with Primary/Secondary Piping)

Mode 5 is designed for outdoor reset and setpoint operation using primary / secondary piping. The heat demand is available to provide outdoor reset for space heating systems. The setpoint demand can be used to heat an indirect domestic hot water tank.

Once a heat demand is present, the control stages the boiler to maintain the calculated outdoor reset target at the boiler supply sensor. Refer to section D for a description of outdoor reset operation.

Once a setpoint demand is present, the control stages the boiler to maintain the boiler target at the boiler supply sensor. If both demands are present at the same time, the control targets the higher of the two requirements. Refer to section B for a description of setpoint operation.

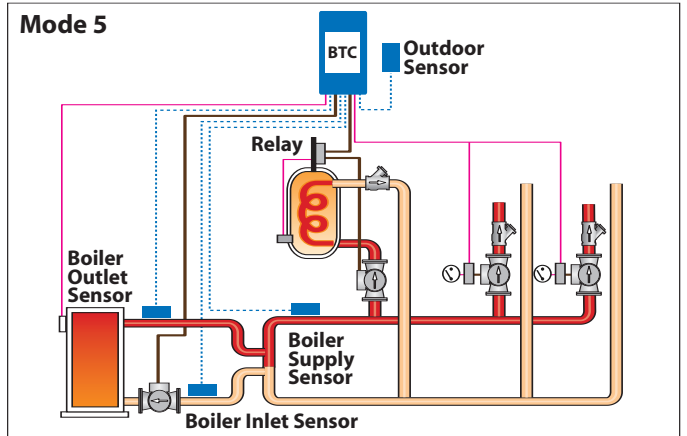

MODE 6 (External Target Temperature Input and Setpoint with Parallel Piping)

Mode 6 is designed for an external input signal and setpoint with parallel piping. The external input signal can be provided from a BMS, an EMS, or a tekmar tN4 System Control for space heating. The setpoint can be used to heat an indirect domestic hot water tank.

The external input signal creates an internal demand and changes the boiler target according to a linear scale. The control stages the boiler to maintain the boiler target at the boiler outlet sensor. Refer to section E for a description of external target temperature operation.

Once a setpoint demand is present, the control stages the boiler to maintain the boiler target at the boiler supply sensor. If both an external input signal and a setpoint demand are present at the same time, the control targets the higher of the two requirements. Refer to section B for a description of setpoint operation.

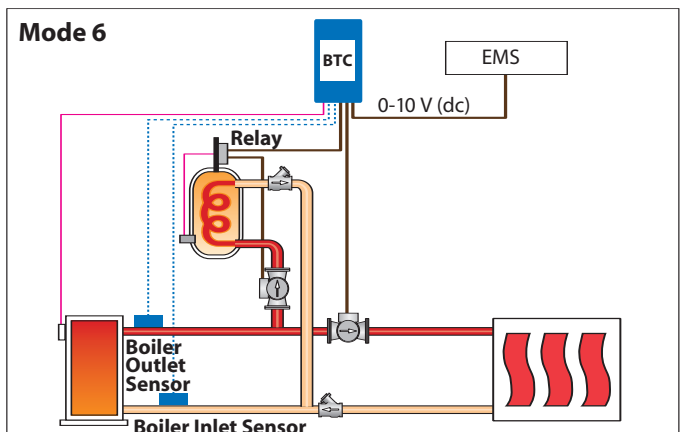

MODE 7 (External Target Temperature Input and Setpoint with Primary/Secondary Piping)

Mode 7 is designed for an external input signal and setpoint with primary/secondary piping. The external input signal can be provided from a BMS, an EMS, or a tekmar tN4 System Control for space heating. The setpoint can be used to heat an indirect domestic hot water tank.

The external input signal creates an internal demand and changes the boiler target according to a linear scale. The control stages the boiler to maintain the boiler target at the boiler outlet sensor. Refer to section E for a description of external target temperature operation.

Once a setpoint demand is present, the control stages the boiler to maintain the boiler target at the boiler supply sensor. If both an external input signal and a setpoint demand are present at the same time, the control targets the higher of the two requirements. Refer to section B for a description of setpoint operation.

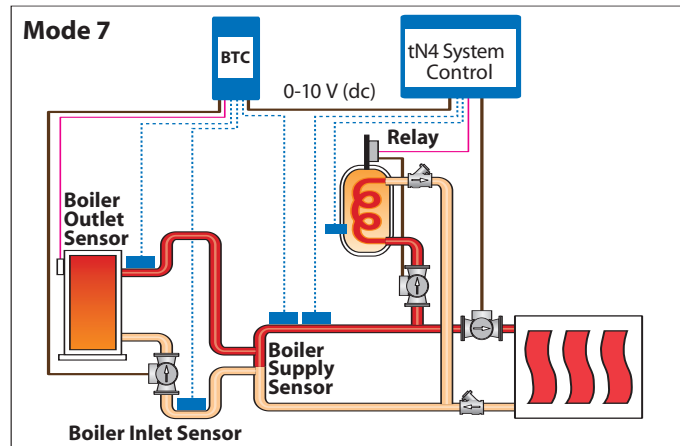

MODE 8 (External Direct Drive Operation)

Mode 8 is designed for an external input signal to directly control the staging rate of the boiler with either parallel or primary / secondary piping. The heat demand and setpoint demand inputs are disabled. Refer to section F for a description of external target temperature operation.

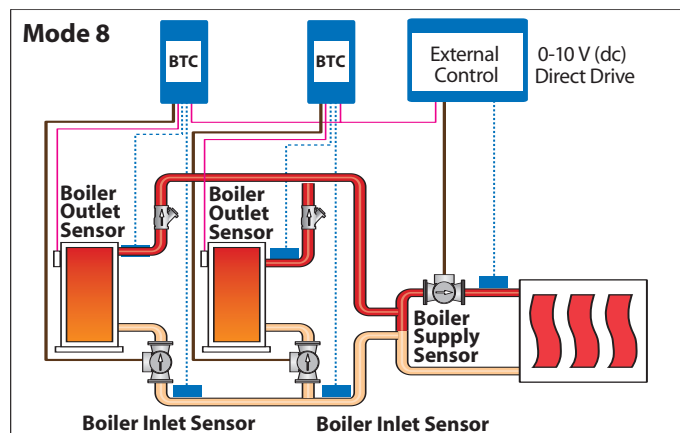

STAGING MODE (STGMODE)

The control can operate up to four stages in order to supply the required target temperature. The method of staging used by the control is either P (proportional) or PID (Proportional & Integral & Derivative), and is selected using the STGMODE item in the Adjust menu.

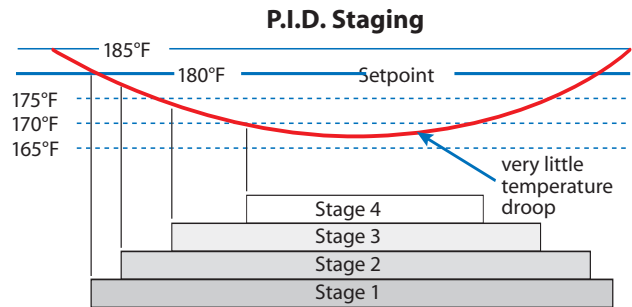
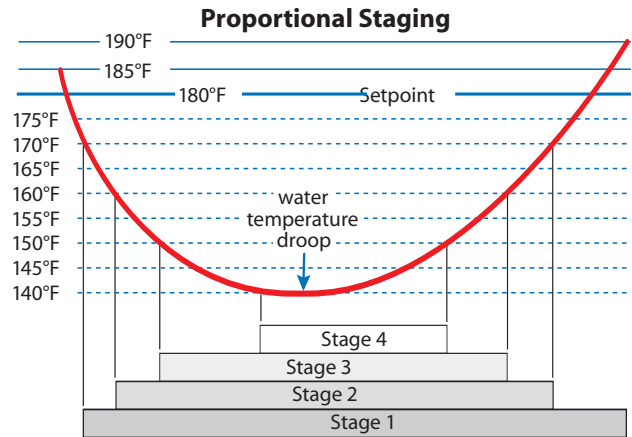

P.I.D. = Proportional + Integral + Derivative

Proportional & Integral & Derivative (PID)

PID staging allows the control to determine when the next stage is required to turn on. After a stage is turned on in the firing sequence, the control waits a minimum amount of time (Stage Delay) before turning on the next stage. After the minimum time delay between stages has expired, the control examines the control error to determine when the next stage is to fire. The control error is determined using PID logic.

Proportional logic compares the actual operating sensor temperature to the boiler target temperature. The colder the temperature, the sooner the next stage is turned on. Integral logic compares the actual operating sensor temperature to the boiler target temperature over a period of time.

Derivative logic determines how fast or slow the operating sensor temperature is changing. If the temperature is increasing slowly, the next stage is turned on sooner. If the temperature is increasing quickly, the next stage is turned on later, if at all.

STAGE DELAY (STG DLY)

The stage delay is the minimum time between firing first to second stage, second to third stage, and third to fourth stage and is determined by the Stage Delay setting. It can be manually set, or it can be set to automatic in which the boiler mass determines the stage delay time.

BOILER MASS (BOIL MASS)

The boiler mass setting allows the installer to adjust the control to the thermal mass of different types of heat sources used. The boiler mass setting automatically determines the stage delay on, stage delay off, minimum on time and minimum off time of the stages. A higher thermal mass setting provides slower staging, while a lower thermal mass provides faster staging.

Proportional (P)

Proportional staging, also known as step staging, is based on manually adjusted settings that determine when the next stage is required to turn on. These manual settings are based on temperature and time. The interstage differential sets the temperature drop at which the next stage turns on. However, in order for a stage to fire, the interstage delay on and minimum off times must first elapse.

Interstage Differential (STG DIFF)

The interstage differential is the temperature drop at which the next stage will turn on. Once a stage turns on, the next stage cannot turn on until the temperature drops the interstage differential below the temperature at which the previous stage turned on. The interstage differential is adjustable through the STG DIFF setting in the Adjust menu.

Interstage On Delay (ON DLY)

The interstage on delay is the amount of time that must elapse before turning on the next stage. Once a stage turns on, the next stage cannot turn on until the interstage delay on time elapses. The interstage on delay is adjustable through the ON DLY setting in the Adjust menu.

Interstage Off Delay (OFF DLY)

The interstage off delay is the amount of time that must elapse before turning off the next stage. Once a stage turns off, the next stage cannot turn off until the interstage delay off time elapses. The interstage off delay is adjustable through the OFF DLY setting in the Adjust menu.

Minimum On Time (MIN ON)

The minimum on time is the minimum amount of time that a stage must be on before it is allowed to turn off. Once a stage turns on, it cannot turn off until a minimum on time elapses. The minimum on time is adjustable through the MIN ON setting in the Adjust menu.

Minimum Off Time (MIN OFF)

The minimum off time is the minimum amount of time that a stage must be off before it is allowed to turn on. Once a stage turns off, it cannot turn on until a minimum off time elapses. The minimum off time is adjustable through the MIN OFF setting in the Adjust menu.

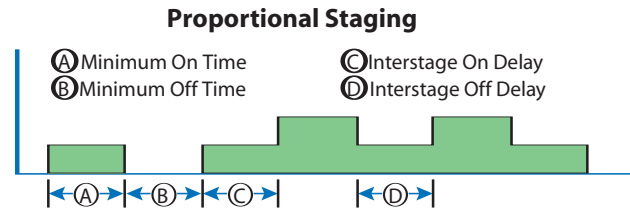

BOILER DIFFERENTIAL (DIFF)

A heat source must be operated with a differential in order to reduce short cycling. The boiler differential is divided around the boiler target temperature. The first stage contact will close once the water temperature at the operating sensor is 1/2 of the differential setting below the boiler target temperature, and will open once the water temperature at the operating sensor is 1/2 of the differential setting above the boiler target temperature.

Manual Differential

The differential can be manually set using the DIFF setting in the Adjust menu.

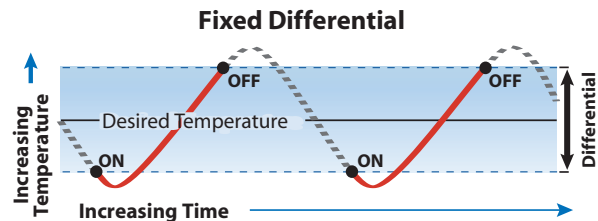

Auto Differential

Auto differential is only available when using PID staging.

If the Auto Differential is selected, the control automatically determines the best differential as the load changes, thereby improving efficiency. During light loads, the differential is increased to allow longer on and off times to reduce the potential for short cycling. During large loads, the differential is narrowed thereby improving comfort in heating spaces by reducing temperature swing.

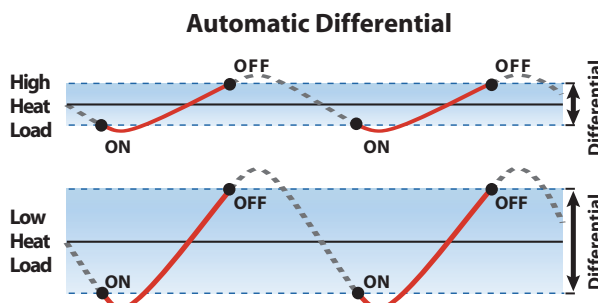

FIRE DELAY (Burner symbol DLY)

Does NOT apply to electric boiler operation.

The Fire Delay is the delay time that may occur between the time that the control closes the Stage 1 contact and when the burner fires. This delay is usually the result of a burner pre-purge or other forms of time delay built into the burner's safety circuits.

BOILER TARGET TEMPERATURE (BOIL TARGET)

The boiler target temperature is determined from the mode of operation and the type of demand applied. The control displays the temperature that it is currently trying to maintain at the operating sensor as BOIL TARGET in the View menu. The operating sensor for modes 1, 3, 4 and 6 is the boiler outlet sensor, and the operating sensor for modes 2, 5 and 7 is the boiler supply sensor. If the control does not presently have a requirement for heat, it displays " - - - " in the LCD. There is no boiler target temperature generated in Mode 8.

BOILER MINIMUM (BOIL MIN)

The BOIL MIN setting is the lowest water temperature that the control is allowed to use as a boiler target temperature. During mild conditions, if the control calculates a boiler target temperature that is below the BOIL MIN setting, the boiler target temperature is adjusted to at least the BOIL MIN setting. During this condition, if the boiler is operating, the MIN segment turns on in the LCD while the boiler target temperature or boiler operating sensor temperature is viewed. If the installed boiler is designed for condensing or low temperature operation, set the BOIL MIN adjustment to OFF.

BOILER MAXIMUM (BOIL MAX)

The BOIL MAX setting is the highest water temperature that the control is allowed to use as a boiler target temperature. If the control does target BOIL MAX, and the temperature at the boiler outlet sensor is near the BOIL MAX temperature, the MAX segment turns on in the LCD while the boiler target, boiler inlet, boiler outlet or boiler supply temperature is viewed.

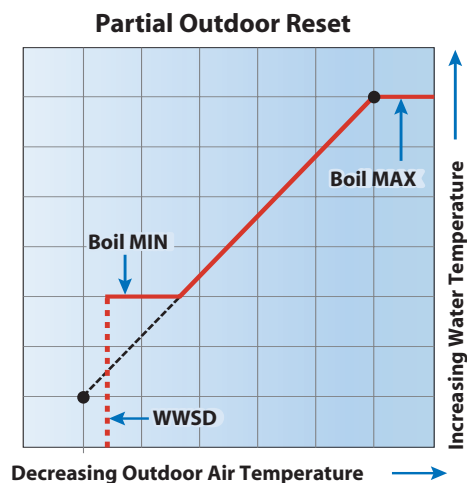

BOILER OUTLET MAXIMUM

The BOIL OUT MAX setting determines the highest water temperature allowed at the boiler outlet sensor. The boiler stages are immediately shut off once the water temperature exceeds the BOIL OUT MAX setting at the boiler outlet sensor location.

BOILER PUMP OPERATION ()

The boiler pump contact operates when:

- A heat demand is present and parallel piping (Mode 1, 3, 4, 6) is used. Parallel piping requires the boiler pump to operate even while the boiler is off in order to provide heat to the system.
- While the boiler is on and primary / secondary piping (Mode 2, 5, 7) is used. Primary / secondary piping reduces standby losses by isolating the boiler from the system while the boiler is off.
- During external direct drive operation (Mode 8), the boiler pump contact closes whenever there is an internal heat demand.
- After the boiler shuts off the boiler pump remains on to purge heat from the boiler to the system.

BOILER PUMP PURGE (DLY)

After the boiler is shut off, the control continues to operate the boiler pump for a period of time. The length of time that the boiler pump continues to run is based on the Pump DLY setting. Once the boiler turns off, the control keeps the boiler pump running for the time selected. This setting allows purging of any excess heat out of the boiler after the boiler is shut off. This also helps to prevent the water in the boiler from flashing into steam after the boiler is shut off.

When Pump DLY is set to OFF, there is no purging. When Pump DLY is set to ON, the pump runs continuously. When on is selected and the control is configured for outdoor reset, the pump continues to run even during Warm Weather Shut

PUMP EXERCISING

If the boiler pump has not operated at least once every 70 hours, the control turns on the output for 10 seconds. This minimizes the possibility of the pump seizing during a long period of inactivity.

ALERT

The control closes the alert contact whenever an error message is present.

Section B: Setpoint Operation

A setpoint is a fixed water temperature target that the boiler is to maintain at the operation sensor once a demand is present. The boiler maintains the boiler target by operating the stages using proportional or PID logic together with the boiler differential.

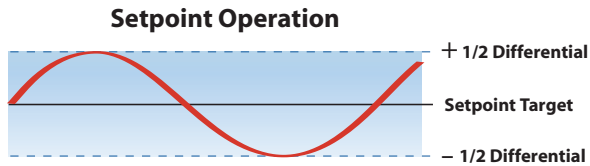

Mode 1 or 2 and Heat Demand (Dem 1)

A heat demand is required whenever heat is required for the primary heating load. A heat demand is generated when a voltage between 24 and 120 V (ac) is applied across the CD (common demand) and the Ht D (heat demand). Once voltage is applied, the control turns on the Dem 1 segment in the display and control operates the boiler stages to maintain the BOIL TARGET 1 at the boiler outlet sensor (Mode 1) or the boiler supply sensor (Mode 2).

Mode 1 or 2 and Setpoint Demand (Dem 2)

A setpoint demand is required whenever heat is required for the secondary heating load such as an indirect domestic hot water tank. A setpoint demand is generated when a voltage between 24 and 120 V (ac) is applied across the CD (common demand) and the Set D (setpoint demand) (pins 1 and 3). Once voltage is applied, the control turns on the Dem 2 segment in the display and control operates the boiler stages to maintain the BOIL TARGET 2 at the boiler outlet sensor (Mode 1) or the boiler supply sensor (Mode 2).

Modes 4 to 7 and Setpoint Demand (Dem 2)

A setpoint demand is required whenever heat is required for the secondary heating load such as an indirect domestic hot water tank. A setpoint demand is generated when a voltage between 24 and 120 V (ac) is applied across the CD (common demand) and the Set D (setpoint demand). Once voltage is applied, the control turns on the Dem 2 segment in the display and control operates the boiler stages to maintain the BOIL TARGET at the boiler outlet sensor (Mode 4, 6) or the boiler supply sensor (Mode 5, 7).

Section C: Dedicated Domestic Hot Water (DHW) Operation

When mode 3 is selected, the BTC provides dedicated DHW operation.

A DHW tank temperature sensor is required to be connected on the Com and the Sup/D terminals (4 and 6). The DHW tank sensor must be installed in an immersion well to measure the tank temperature.

The TANK TARGET setting is used to set the desired DHW tank temperature. The TANK DIFF setting is the differential below the target.

An internal heat demand for DHW is generated when the measured DHW tank temperature falls below the TANK TARGET - TANK DIFF. The internal heat demand is removed once the measured DHW tank temperature exceeds the TANK TARGET.

Once an internal demand is generated, the Dem 1 segment turns on in the LCD. The control then closes the Pump contact, which starts the boiler pump and the control turns on the boiler pump segment in the display. The control then operates the boiler stages to maintain the programmed tank target temperature.

Note: A voltage does not need to be applied to the heat demand or the setpoint demand in this mode of operation.

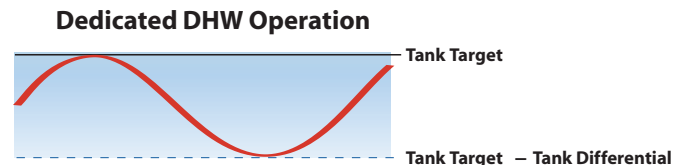

Section D: Outdoor Reset Operation

When either mode 4 or 5 is selected, the control uses outdoor reset to control the water temperature while a heat demand is present. Outdoor reset calculates the boiler target temperature based on the outdoor air temperature and reset ratio. As a result, the boiler target changes proportional to the outdoor temperature. The reset ratio is determined from the Boiler Start, Boiler Design, Outdoor Start and Outdoor Design settings.

HEAT DEMAND (Dem 1)

A heat demand is required whenever heat is required in the system. A heat demand is generated when a voltage between 24 and 120 V (ac) is applied across the CD (common demand) and the Ht D (heat demand) pins.

Once voltage is applied, the control turns on the Dem 1 segment in the display. If the control is not in warm weather shut down (WWSD), the control calculates a boiler target based on the reset ratio and outdoor air temperature. The pump and the boiler stages are operated to maintain the boiler target at the boiler outlet sensor (Mode 4), or the boiler supply sensor (Mode 5).

If the control is in WWSD, the WWSD segment is shown in the display and the boiler target in the View menu of the display remains “---” (no target).

RESET RATIO

The control uses the four following settings to determine the reset ratio:

Boiler Start (BOIL START)

The BOIL START temperature is the theoretical boiler supply water temperature that the heating system requires when the outdoor air temperature equals the OUTDR START temperature setting. The BOIL START is typically set to the desired building temperature.

Outdoor Start (OUTDR START)

The OUTDR START temperature is the outdoor air temperature at which the control provides the BOIL START water temperature to the system. The OUTDR START is typically set to the desired building temperature.

Outdoor Design (OUTDR DSGN)

The OUTDR DSGN is the outdoor air temperature that is the typical coldest temperature of the year where the building is located. This temperature is used when completing heat loss calculations for the building.

Boiler Design (BOIL DSGN)

The BOIL DSGN temperature is the water temperature required to heat the boiler zones when the outdoor air is as cold as the OUTDR DSGN temperature.

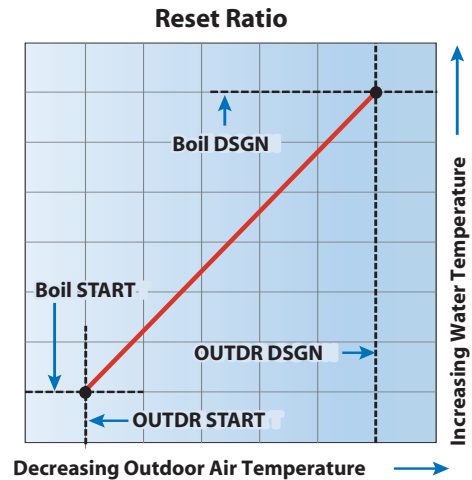

Warm Weather Shut Down (WWSD)

When the outdoor air temperature rises above the WWSD setting, the control enters WWSD and turns on the WWSD segment in the display. Once the outdoor air temperature falls below the WWSD setting, the control exits WWSD. When the control is in Warm Weather Shut Down, the Dem 1 segment is displayed if there is a heat demand. However, the control does not operate the boiler to satisfy the heat demand. The control continues to respond to setpoint demands.

Section E: External Temperature Target Input

When modes 6 or 7 are selected, the control allows for an external control to operate the boiler temperature through an external input signal provided by a Building Management System (BMS), Energy Management System (EMS), or tekmar tN4 System Control. When in modes 6 or 7, the external heat demand (CD and Ht D) are disabled. The setpoint demand continues to operate as normal.

INTERNAL HEAT DEMAND

An internal heat demand is generated when an analog positive 0-10 V (dc) or 2-10 V (dc) signal is applied to the +V(in) input. The negative V (dc) signal is applied to the Com/- input.

0-10 V (dc) or 0-20 mA External Input Signal

The external input signal can be selected to be either 0-10 V (dc) or 2-10 V (dc) range. When the 0-10 V (dc) range is selected, an input voltage of 1 V (dc) corresponds to a boiler target temperature of 50°F (10°C). An input voltage of 10 V (dc) corresponds to a boiler target temperature of 210°F (99°C). As the voltage varies between 1 V (dc) and 10 V (dc), the boiler target temperature varies linearly between 50°F (10°C) and 210°F (99°C). If a voltage below 0.5 V (dc) is received, the boiler target temperature is displayed as “ – – – ” indicating that there is no longer an internal heat demand.

A 0-20 mA signal can be converted to a 0-10 V (dc) signal by installing a 500 Ohm resistor on the external input signal device's terminals.

A 4-20 mA signal can be converted to a 2-10 V (dc) signal by installing a 500 ohm resistor on the external input signal device's terminals.

0-10 V (dc)	0-20 mA*	Boiler Target
0	0	--- (OFF)
1	2	50°F (10°C)
2	4	68°F (20°C)
3	6	86°F (30°C)
4	8	103°F (39°C)
5	10	121°F (49°C)
6	12	139°F (59°C)
7	14	157°F (69°C)
8	16	174°F (79°C)
9	18	192°F (89°C)
10	20	210°F (99°C)

*requires a 500 Ω resistor

2-10 V (dc)	4-20 mA*	Boiler Target
0	0	--- (OFF)
1	2	--- (OFF)
2	4	50°F (10°C)
3	6	70°F (21°C)
4	8	90°F (32°C)
5	10	110°F (43°C)
6	12	130°F (54°C)
7	14	150°F (66°C)
8	16	170°F (77°C)
9	18	190°F (88°C)
10	20	210°F (99°C)

*requires a 500 Ω resistor

2-10 V (dc) or 4-20 mA External Input Signal

The external input signal can be selected to be either 0-10 V (dc) or 2-10 V (dc) range. When the 2-10 V (dc) range is selected, an input voltage of 2 V (dc) corresponds to a boiler target temperature of 50°F (10°C). An input voltage of 10 V (dc) corresponds to a boiler target temperature of 210°F (99°C). As the voltage varies between 2 V (dc) and 10 V (dc), the boiler target temperature varies linearly between 50°F (10°C) and 210°F (99°C). If a voltage below 1.5 V (dc) is received the boiler target temperature is displayed as “ --- ” indicating that there is no longer an internal heat demand.

OFFSET

The Offset setting allows the boiler target temperature to be fine tuned to the external input signal. The control reads the external input signal and converts this to a boiler target temperature. The Offset setting is then added to the boiler target temperature.

Example	Range	= 0-10 V (dc)	
	Input	= 7 V (dc)	→ 157°F (69°C)
	Offset	= + 5°F (3°C)	→ 5°F (3°C)
	Boiler Target	=	162°F (72°C)

Section F: External Direct Drive Operation

When mode 8 is selected, the control allows for an external control to operate the boiler through an analog direct drive input signal provided by a boiler sequencing control such as a tekmar Boiler Control 275. When in mode 8, the external heat demand (CD and Ht D) and the setpoint demand (CD and Set D) are disabled.

DIRECT DRIVE INPUT SIGNAL

An external boiler sequencer provides a positive 0-10 V (dc) input signal to the control +V(in) input. The negative V (dc) signal is applied to the Com/- input.

The boiler burner remains off while the direct drive input signal range is between 0 to 0.5 V (dc). The Stage 1 contact remains on as long as the direct drive input signal is over 0.5 V (dc). The Stage 2 contact is activated once the direct drive input signal reaches or exceeds 3.0 V (dc). Stage 3 contact is activated once the direct drive input signal reaches or exceeds 5.5 V (dc). Stage 4 contact is activated once the direct drive input signal reaches or exceeds 8.0 V (dc).

PUMP OPERATION

The pump is turned on as soon as the direct drive input signal reaches 0.5 V (dc). Once the direct drive input signal falls below 0.5 V (dc), the pump continues to operate until the Pump DLY purge expires, then the pump shuts off.

BOILER OUTLET MAXIMUM TEMPERATURE

The external boiler sequencer is able to operate the boiler temperature. However, the BOIL OUT MAX setting limits the highest temperature at the boiler outlet sensor. Should the boiler outlet temperature exceed the BOIL OUT MAX setting, the Stage contacts are opened to shut off the burner. The burners remains off for the minimum off time and the boiler outlet temperature falls 2°F (1°C) below the BOIL OUT MAX setting.

Installation

Electrical Connections to the Control

The installer should test to confirm that no voltage is present at any of the wires during installation. The control includes a 24 pin connector for ease of installation.

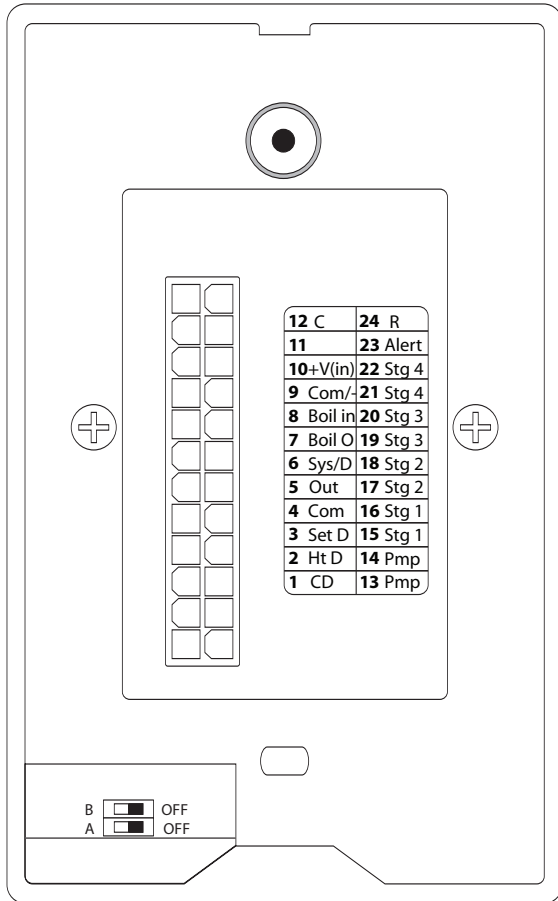

Powered Input Connections

24 V (ac) Power

Connect the 24 V (ac) power supply to the C and R terminals. This connection provides power to the microprocessor and display of the control. As well, this connection provides power to the Alert terminal from the R terminal.

Heat Demand

To generate a heat demand, a voltage between 24 V (ac) and 120 V (ac) must be applied across the CD (common demand) and the Ht D (heat demand) pins.

Setpoint Demand

To generate a setpoint demand, a voltage between 24 V (ac) and 120 V (ac) must be applied across the CD (common demand) and the Set D (setpoint demand) pins.

Caution: The same power supply must be used for both the heat demand and setpoint demand circuits since they share the CD (common demand) pin.

Output Connections

Boiler Pump Contact

The Pump pins are an isolated output in the control. There is no power available on these pins from the control. This output is to be used as a switch to either make or break power to the boiler pump. Since this is an isolated contact, it may switch a voltage between 24 V (ac) and 120 V (ac).

Stage Contacts

Stage 1, Stage 2, Stage 3, and Stage 4 are isolated outputs in the control. There is no power available on these pins from the control. This output is to be used as a switch to either make or break the stage circuits. When the control requires the stage to fire, it closes the Stage contact.

Alert Contact

The Alert pin on the control is connected to an audible alarm on the interface board which sounds an alert when it senses an open sensor circuit.

Sensor and Unpowered Input Connections

Do not apply power to these terminals as this damages the control.

Boiler Outlet Sensor

Connect the two wires from the Boiler Outlet Sensor to the Com/- (common sensor) and Boil O (boiler outlet sensor) pins. The boiler outlet sensor is used by the control to measure the boiler outlet water temperature from the boiler.

Note: The boiler outlet sensor is required for every mode of operation.

Boiler Inlet Sensor

Connect the two wires from the Boiler Inlet Sensor to the Com/- (common sensor) and Boil in (boiler inlet sensor) pins. The boiler inlet sensor is used by the control to measure the boiler inlet water temperature from the boiler.

Note: The boiler inlet sensor is optional for every mode of operation.

Boiler Supply Sensor

An optional Boiler Supply Sensor may be connected to the control. If the sensor is required, connect the two wires from the sensor to the Com (common sensor) and Sys/D (boiler supply) pins.

DHW Tank Sensor

An optional DHW Tank Sensor may be connected to the control. If the sensor is required, connect the two wires from the sensor to the Com (common sensor) and Sys/D (DHW) pins.

Outdoor Sensor

An optional Outdoor Sensor may be connected to the control. If the sensor is required, connect the two wires from the Outdoor Sensor to the Com (common sensor) and Out (outdoor sensor) pins. The outdoor sensor is used by the control to measure the outdoor air temperature.

External Input

The control can accept an external input signal from an external control. If an external input signal is required, connect the positive 0-10 V (dc) wire to the +V(in) pin and connect the negative 0-10 V (dc) wire to the Com/- pin.

Testing

The wiring harness must be unplugged from the connector on the control before testing. To remove the wiring harness, push down on the tab on the connector and pull away from the control.

The following tests are performed using standard testing practices and procedures and should only be carried out by properly trained and experienced persons.

A good quality electrical test meter, capable of reading from at least 0-300 V (ac) and at least 0-2,000,000 Ohms, is essential to properly test the wiring and sensors.

TEST THE SENSORS

In order to test the sensors, the actual temperature at each sensor location must be measured. A good quality digital thermometer with a surface temperature probe is recommended for ease of use and accuracy. First measure the temperature using the thermometer and then measure

the resistance of the sensor at the control. Using the chart below, estimate the temperature measured by the sensor. The sensor and the thermometer readings should be close. If the meter reads a very high resistance, there may be a broken wire, a poor wiring connection or a defective sensor. If the resistance is very low, the wiring may be shorted, there may be moisture in the sensor or the sensor may be defective. To test for a defective sensor, measure the resistance directly at the sensor location.

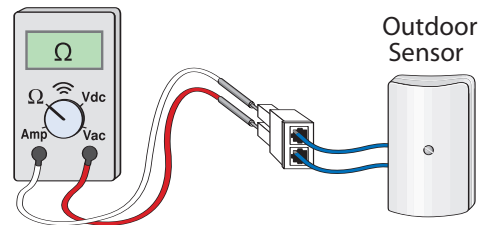

Temperature		Resistance	Temperature		Resistance	Temperature		Resistance	Temperature		Resistance
°F	°C	Ω	°F	°C	Ω	°F	°C	Ω	°F	°C	Ω
-50	-46	490,813	20	-7	46,218	90	32	7,334	160	71	1,689
-45	-43	405,710	25	-4	39,913	95	35	6,532	165	74	1,538
-40	-40	336,606	30	-1	34,558	100	38	5,828	170	77	1,403
-35	-37	280,279	35	2	29,996	105	41	5,210	175	79	1,281
-30	-34	234,196	40	4	26,099	110	43	4,665	180	82	1,172
-25	-32	196,358	45	7	22,763	115	46	4,184	185	85	1,073
-20	-29	165,180	50	10	19,900	120	49	3,760	190	88	983
-15	-26	139,402	55	13	17,436	125	52	3,383	195	91	903
-10	-23	118,018	60	16	15,311	130	54	3,050	200	93	829
-5	-21	100,221	65	18	13,474	135	57	2,754	205	96	763
0	-18	85,362	70	21	11,883	140	60	2,490	210	99	703
5	-15	72,918	75	24	10,501	145	63	2,255	215	102	648
10	-12	62,465	80	27	9,299	150	66	2,045	220	104	598
15	-9	53,658	85	29	8,250	155	68	1,857	225	107	553

TEST THE POWER SUPPLY

Make sure exposed wires are not in contact with other wires or grounded surfaces. Turn on the power and measure the voltage between the C and R pins using an AC voltmeter, the reading should be between 22 and 26 V (ac).

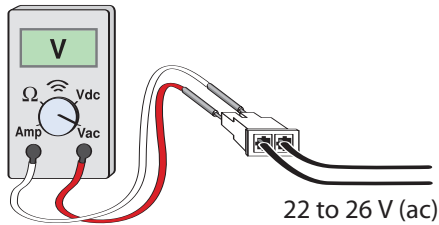

TEST THE POWERED INPUTS

Heat Demand

If a heat demand is used, measure the voltage between the CD (common demand) and the Ht D (heat demand) pins. When the heat demand device calls for heat, between 20 and 130 V (ac) should be measured at the pins. When the heat demand device is off, less than 5 V (ac) should be measured.

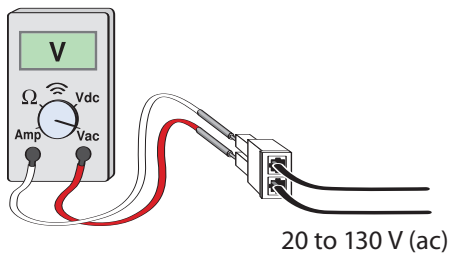

Setpoint Demand

If a setpoint demand is used, measure the voltage between the CD (common demand) and the Set D (setpoint demand) pins. When the setpoint demand device calls for heat, between 20 and 130 V (ac) should be measured at the pins. When the setpoint demand device is off, less than 5 V (ac) should be measured.

Test the External Input

If an external input signal is used, measure the voltage between the Com/- and +V(in) pins. When the external control calls for heat, between 0 and 10 V (dc) should be measured.

CONNECTING THE CONTROL

Make sure all power to the devices and wiring harness is off.

Reconnect the wiring harness to the connector on the control by aligning the tab on the wiring harness to the tab on the connector on the control and then pushing the wiring harness into the connector on the control. The tab on the wiring harness should snap over the tab on the connector of the control.

Apply power to the control. The operation of the control on power up is described in the Sequence of Operation section of the brochure.

TESTING THE CONTROL OUTPUTS

The control has a built-in test routine that is used to override the main control functions. The test sequence is enabled when the ▲ button is pressed and held for 3 seconds while in the View menu. The test sequence can be cancelled by pressing either the Item, ▲ or ▼ button. Once the test sequence is enabled, the outputs are tested in the following sequence.

Press and hold the ▲ button for 3 seconds while in the View menu.

Step 1	Boil	The boiler pump is turned on.
Step 2	Boil 1	Stage 1 heating element(s) on.
Step 3	Boil 12	Stage 2 heating element(s) on.
Step 4	Boil 123	Stage 3 heating element(s) on.
Step 5	Boil 1234	Stage 4 heating element(s) on.
Step 6		The boiler pump and stages 1 to 4 are shut off. The alert is closed for 10 seconds.

The control exits the test sequence and resumes normal operation.

Control Settings

DIP Switch Settings

Note: DIP switches are located on the front of the control.

(A) Factory / Installer

The Factory / Installer DIP switch is used to select which items are available to be viewed and / or adjusted in the user interface. The Factory Access Level includes all the settings available in the control. The Installer Access Level includes the settings and items which are required for system setup.

(B) Not Used

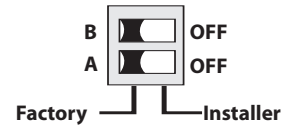

Mode 1 and 2 – Two Setpoint Operation

Applications

Mode 1 – Two Setpoint Operation with Parallel Piping

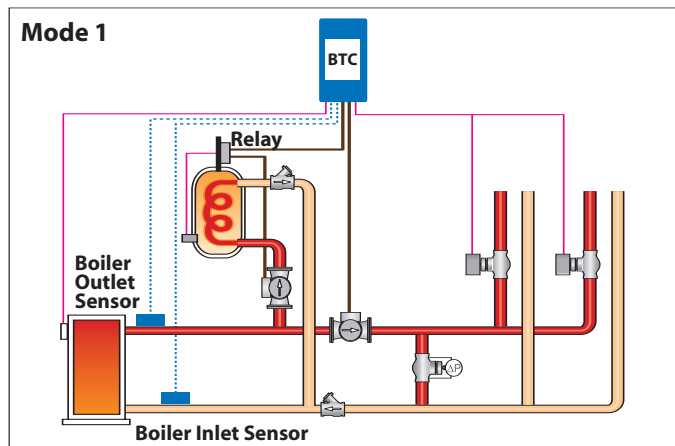

The control receives a heat demand provided from zone valve end switches or a switching relay end switch. The control turns on the boiler pump and operates the burners to maintain the setpoint boiler target 1 temperature at the boiler outlet sensor whenever a heat demand is present. The control receives a setpoint demand from a DHW aquastat. The control operates the burners to maintain the setpoint boiler target 2 at the boiler outlet sensor whenever a setpoint demand is present.

Note: An external relay is required to operate the DHW pump and provide DHW priority if required by disabling the boiler pump.

Mode 2 – Two Setpoint Operation with Primary / Secondary Piping

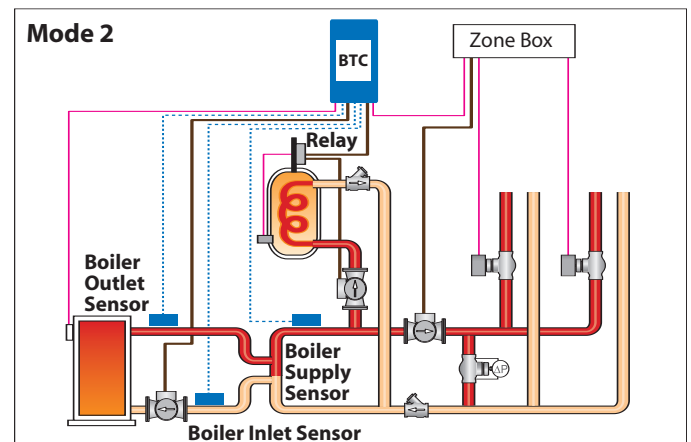

The control receives a heat demand provided from zone valve end switches or a switching relay end switch. The control turns on the boiler pump and operates the burners to maintain the boiler target 1 temperature at the boiler supply sensor whenever a heat demand is present. The control receives a setpoint demand from a DHW aquastat. The control operates the burners to maintain the setpoint boiler target 2 at the boiler supply sensor whenever a setpoint demand is present.

Note: An external relay is required to operate the DHW pump and provide DHW priority if required by disabling the system pump.

Mode 1 and 2 – Two Setpoint Operation - View Menu

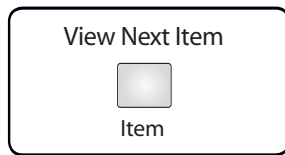

The View menu items display current operating temperatures and system status information. Use the Item button to view items in this menu.

VIEW MENU

Item Field	Range	Description	Access
	---, 35 to 266°F (2 to 130°C), OFF	BOILER TARGET The boiler target is the temperature the control is currently trying to maintain at the boiler supply sensor or the boiler outlet sensor.	Factory Installer
	14 to 266°F (-10 to 130°C)	BOILER SUPPLY Current boiler supply water temperature as measured by the boiler supply sensor. Note: This item is only available when MODE is set to 2.	Factory Installer
	14 to 266°F (-10 to 130°C)	BOILER OUTLET Current boiler outlet water temperature as measured by the boiler outlet sensor. Note: When MODE is set to 2 this item is only visible in the Factory access level.	Factory <i>(Installer for Mode 1)</i>
	14 to 266°F (-10 to 130°C)	BOILER INLET Current boiler inlet water temperature as measured by the boiler inlet sensor. Note: This item is only available when a boiler inlet sensor is installed.	Factory Installer
	0 to 252°F (0 to 140°C)	BOILER DELTA T Current temperature difference between the boiler outlet sensor and the boiler inlet sensor. Note: This item is only available when a boiler inlet sensor is installed.	Factory
	0 to 999	BOILER ON HOURS The total number of running hours of the boiler since this item was last cleared. Clear the numbers of hours by pressing and holding the ? and ? buttons together while viewing this item.	Factory

After the last item, the control returns to the first item in the menu.

Mode 1 and 2 – Two Setpoint Operation - Adjust Menu (1 of 2)

Enter Adjust Menu

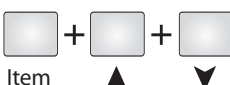

Item ▲ ▼

Next Item



Item

Change Value

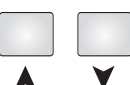

▲ ▼

The Program menu items are the programmable settings used to operate the system. **Press and hold all three buttons simultaneously** to enter the Program menu.

ADJUST MENU

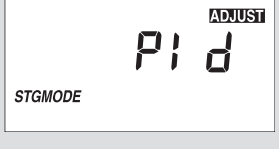
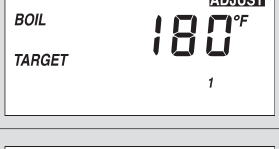
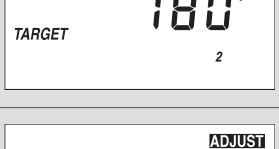
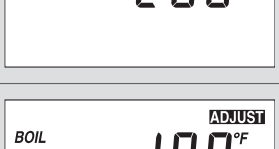
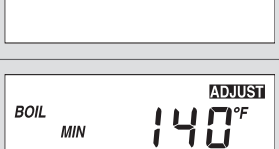
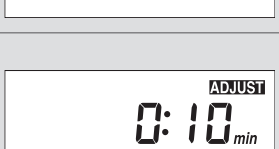
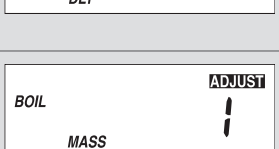
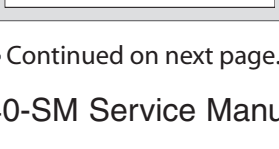
Item Field	Range	Description	Access	Setting
 <p>MODE</p>	1 to 8	MODE Select the operating mode for the control.	Factory Installer	Default Setting 4
 <p>STG MODE</p>	Pld or P	STAGE MODE Select the staging operation to be either automatic or manual. (Pld = automatic) (P = proportional)	Factory Installer	
 <p>BOIL TARGET</p>	OFF, 70 to 220°F (21 to 104°C)	BOILER TARGET 1 Select the boiler target temperature while a heat demand is present.	Factory Installer	
 <p>BOIL TARGET</p>	OFF, 70 to 220°F (21 to 104°C)	BOILER TARGET 2 Select the boiler target temperature while a setpoint demand is present.	Factory Installer	
 <p>BOIL OUT MAX</p>	120 to 225°F (49 to 107°C)	BOILER OUTLET MAXIMUM Select the maximum boiler outlet temperature. Exceeding this temperature shuts off the boiler.	Factory	
 <p>BOIL MAX</p>	120 to 225°F (49 to 107°C), OFF	BOILER MAXIMUM Select the maximum boiler target temperature.	Factory	
 <p>BOIL MIN</p>	OFF, 80 to 180°F (27 to 82°C)	BOILER MINIMUM Select the minimum boiler target temperature.	Factory	
 <p>DLY</p>	0:00 to 3:00 min (1 second increments)	FIRE DELAY (Not valid for electric boiler application) Select the amount of time required for combustion pre-purging, ignition and the flame to be established. Note: This setting is only available when STAGE MODE is set to Pld.	Factory	NOT VALID FOR ELECTRIC BOILER APPLICATION
 <p>BOIL MASS</p>	1 (Lo) or 2 (Med) or 3 (Hi)	BOILER MASS Select the thermal mass of the boiler. Note: This setting is only available when STAGE MODE is set to Pld.	Factory Installer	

Continued on next page.

Mode 1 and 2 – Two Setpoint Operation - Adjust Menu (2 of 2)

ADJUST MENU

Item Field	Range	Description	Access	Setting
	Au, 0:30 to 9:55 min	STAGE DELAY Select the minimum time delay between stages. Note: This setting is only available when STAGE MODE is set to Pld.	Factory Installer	
	Au, 2 to 42°F (1 to 23°C)	DIFFERENTIAL Select the boiler differential. Note: The automatic setting is only available when STAGE MODE is set to Pld staging.	Factory	
	0 to 10°F (0 to 6°C)	STAGE DIFFERENTIAL Select the interstage temperature differential between stages for proportional staging. Note: This setting is only available when STAGE MODE is set to P.	Factory	
	0:10 to 8:00 min	INTERSTAGE ON DELAY Select the amount of time that must pass once a stage has been turned on in order to allow the next stage to turn on. Note: This setting is only available when STAGE MODE is set to P.	Factory	
	0:10 to 4:00 min	INTERSTAGE OFF DELAY Select the amount of time that must pass once a stage has been turned off in order to allow the next stage to turn off. Note: This setting is only available when STAGE MODE is set to P.	Factory	
	0:10 to 5:00 min	MINIMUM ON TIME Select the minimum amount of time that the stage contact must remain on before it is allowed to turn off. Note: This setting is only available when STAGE MODE is set to P.	Factory	
	0:10 to 5:00 min	MINIMUM OFF TIME Select the minimum amount of time that the stage contact must remain off before it is allowed to turn back on. Note: This setting is only available when STAGE MODE is set to P.	Factory	
	OFF, 0:20 to 9:55 min, On	PUMP DELAY Select the boiler pump purge time after shutting off the boiler.	Factory	
	°F or °C	TEMPERATURE UNITS Select to display temperature in degrees Fahrenheit or in degrees Celsius.	Factory Installer	

After the last item, the control returns to the first item in the menu.

Mode 3 – Dedicated Domestic Hot Water Tank with Parallel Piping

Application

Mode 3 - Dedicated DHW with Parallel Piping

The control measures the tank temperature using a DHW sensor. Once the tank temperature falls the tank differential below the tank setpoint, an internal heat demand is created. The boiler pump is turned on and the boiler is operated to maintain the tank target temperature.

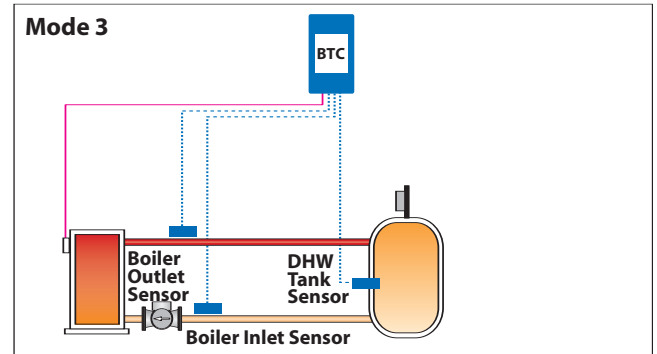

Mode 3 – Dedicated DHW with Parallel Piping - View Menu

View Next Item

Item

The View menu items display current operating temperatures and system status information. Use the Item button to view items in this menu.

VIEW MENU

Item Field	Range	Description	Access
<div style="border: 1px solid black; padding: 5px;"> <p style="text-align: right; margin: 0;">VIEW</p> <p style="font-size: 24pt; text-align: center; margin: 0;">120^{°F}</p> <p>TARGET TANK</p> </div>	<p>---, 35 to 266°F (2 to 130°C), OFF</p>	<p>TANK TARGET The temperature that the control is trying to maintain in the tank.</p>	Factory Installer
<div style="border: 1px solid black; padding: 5px;"> <p style="text-align: right; margin: 0;">VIEW</p> <p style="font-size: 24pt; text-align: center; margin: 0;">180^{°F}</p> <p>BOIL OUT</p> </div>	<p>14 to 266°F (-10 to 130°C)</p>	<p>BOILER OUTLET Current boiler outlet water temperature as measured by the boiler outlet sensor.</p>	Factory Installer
<div style="border: 1px solid black; padding: 5px;"> <p style="text-align: right; margin: 0;">VIEW</p> <p style="font-size: 24pt; text-align: center; margin: 0;">152^{°F}</p> <p>BOIL IN</p> </div>	<p>14 to 266°F (-10 to 130°C)</p>	<p>BOILER INLET Current boiler inlet water temperature as measured by the boiler inlet sensor. Note: This item is only available when a boiler inlet sensor is installed.</p>	Factory Installer
<div style="border: 1px solid black; padding: 5px;"> <p style="text-align: right; margin: 0;">VIEW</p> <p style="font-size: 24pt; text-align: center; margin: 0;">27^{°F}</p> <p>BOIL ΔT</p> </div>	<p>0 to 252°F (0 to 140°C)</p>	<p>BOILER DELTA T Current temperature difference between the boiler outlet sensor and the boiler inlet sensor. Note: This item is only available when a boiler inlet sensor is installed.</p>	Factory
<div style="border: 1px solid black; padding: 5px;"> <p style="text-align: right; margin: 0;">VIEW</p> <p style="font-size: 24pt; text-align: center; margin: 0;">140^{°F}</p> <p>TANK</p> </div>	<p>14 to 266°F (-10 to 130°C)</p>	<p>TANK Current domestic hot water tank temperature as measured by the DHW tank sensor.</p>	Factory Installer
<div style="border: 1px solid black; padding: 5px;"> <p style="text-align: right; margin: 0;">VIEW</p> <p style="font-size: 24pt; text-align: center; margin: 0;">999</p> <p>BOIL ON</p> </div>	<p>0 to 999</p>	<p>BOILER ON HOURS The total number of running hours of the boiler since this item was last cleared. Clear the numbers of hours by pressing and holding the ? and ? buttons together while viewing this item.</p>	Factory

After the last item, the control returns to the first item in the menu.

Mode 3 – Dedicated DHW with Parallel Piping - Adjust Menu (1 of 2)

Enter Adjust Menu

Item ▲ ▼

Next Item

Item

Change Value

▲ ▼

The Program menu items are the programmable settings used to operate the system. **Press and hold all three buttons simultaneously** to enter the Program menu.







ADJUST MENU

Item Field	Range	Description	Access	Setting
<p>MODE</p>	1 to 8	MODE Select the operating mode for the control.	Factory Installer	Default Setting 4
<p>STG MODE</p>	Pld or P	STAGE MODE Select the staging operation to be either automatic or manual. (Pld = automatic) (P = proportional)	Factory Installer	
<p>TARGET TANK</p>	OFF, 70 to 190°F (21 to 88°C)	TANK TARGET Select the dedicated domestic hot water tank target temperature.	Factory Installer	
<p>DIFF TANK</p>	Au, 2 to 10°F (1 to 6°C)	TANK DIFFERENTIAL Select the dedicated domestic hot water tank differential. The DHW sensor temperature must fall below this setting before the boiler will turn on.	Factory Installer	
<p>BOILER OUT MAX</p>	120 to 225°F (49 to 107°C)	BOILER OUTLET MAXIMUM Select the maximum boiler outlet temperature. Exceeding this temperature shuts off the boiler.	Factory	
<p>DLY</p>	0:00 to 3:00 min (1 second increments)	FIRE DELAY Select the amount of time required for combustion pre-purging, ignition and the flame to be established. Note: This setting is only available when STAGE MODE is set to Pld.	Factory	NOT VALID FOR ELECTRIC BOILER APPLICATION
<p>BOILER MASS</p>	1 (Lo) or 2 (Med) or 3 (Hi)	BOILER MASS Select the thermal mass of the boiler. Note: This setting is only available when STAGE MODE is set to Pld.	Factory Installer	

Continued on next page.

Mode 3 – Dedicated DHW with Parallel Piping - Adjust Menu (2 of 2)

ADJUST MENU

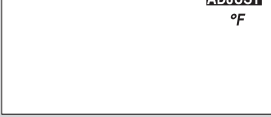
Item Field	Range	Description	Access	Setting
	Au, 0:30 to 9:55 min	STAGE DELAY Select the minimum time delay between stages. Note: This setting is only available when STAGE MODE is set to Pld.	Factory Installer	
	0 to 10°F (0 to 6°C)	STAGE DIFFERENTIAL Select the interstage temperature differential between stages for proportional staging. Note: This setting is only available when STAGE MODE is set to P.	Factory	
	0:10 to 8:00 min	INTERSTAGE ON DELAY Select the amount of time that must pass once a stage has been turned on in order to allow the next stage to turn on. Note: This setting is only available when STAGE MODE is set to P.	Factory	
	0:10 to 4:00 min	INTERSTAGE OFF DELAY Select the amount of time that must pass once a stage has been turned off in order to allow the next stage to turn off. Note: This setting is only available when STAGE MODE is set to P.	Factory	
	0:10 to 5:00 min	MINIMUM ON TIME Select the minimum amount of time that the stage contact must remain on before it is allowed to turn off. Note: This setting is only available when STAGE MODE is set to P.	Factory	
	0:10 to 5:00 min	MINIMUM OFF TIME Select the minimum amount of time that the stage contact must remain off before it is allowed to turn back on. Note: This setting is only available when STAGE MODE is set to P.	Factory	
	OFF, 0:20 to 9:55 min, On	PUMP DELAY Select the boiler pump purge time after shutting off the boiler.	Factory	
	°F or °C	TEMPERATURE UNITS Select to display temperature in degrees Fahrenheit or in degrees Celsius.	Factory Installer	

• After the last item, the control returns to the first item in the menu.

Mode 4 and 5 – Outdoor Reset and Setpoint Operation

Applications

Mode 4 – Outdoor Reset and Setpoint with Parallel Piping

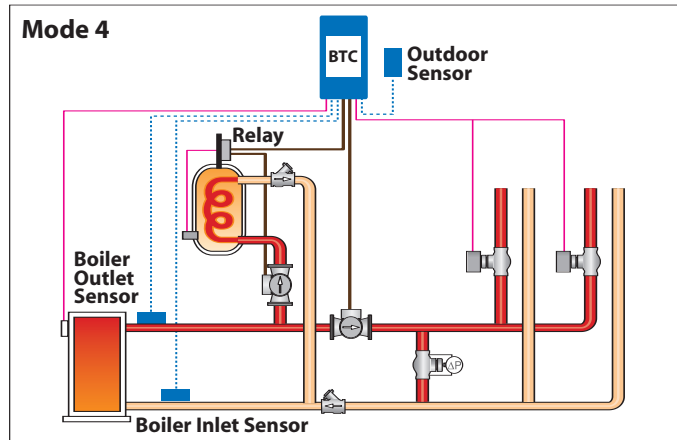

The control receives a heat demand provided from zone valve end switches or a switching relay end switch. The control turns on the boiler pump and operates the boiler to maintain the outdoor reset boiler temperature at the boiler outlet sensor. The control receives a setpoint demand from a DHW aquastat. The control turns on the boiler pump and operates the boiler to maintain the setpoint boiler target temperature at the boiler outlet sensor whenever a setpoint demand is present.

Note: An external relay is required to operate the DHW pump and provide DHW priority if required by disabling the boiler pump.

Mode 5 – Outdoor Reset and Setpoint with Primary – Secondary Piping

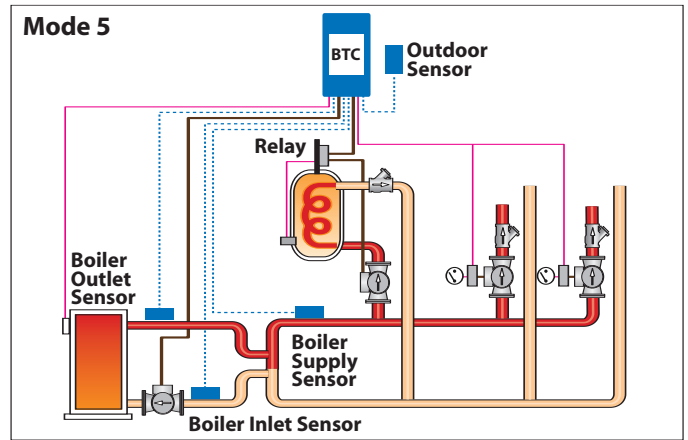

The control receives a heat demand provided from zone pump end switches or switching relay end switch. The control turns on the boiler pump and operates the boiler to maintain the outdoor reset target temperature at the boiler supply sensor. The control receives a setpoint demand from a DHW aquastat. The control turns on the boiler pump and operates the boiler to maintain the setpoint boiler target temperature at the boiler supply sensor whenever a setpoint demand is present.

Note: An external relay is required to operate the DHW pump and provide DHW priority if required by disabling the system pump or zone pumps.

Mode 4 and 5 – Outdoor Reset and Setpoint Operation - View Menu

View Next Item



Item

The View menu items display current operating temperatures and system status information. Use the Item button to view items in this menu.

VIEW MENU

Item Field	Range	Description	Access
OUTDR VIEW 63°F	-60 to 190°F (-51 to 88°C)	OUTDOOR Current outdoor air temperature as measured by the outdoor sensor.	Factory Installer
BOIL TARGET VIEW 180°F	---, 35 to 266°F (2 to 130°C), OFF	BOILER TARGET The boiler target is the temperature the control is currently trying to maintain at the boiler supply sensor or the boiler outlet sensor.	Factory Installer
BOILSUP VIEW 178°F	14 to 266°F (-10 to 130°C)	BOILER SUPPLY Current boiler supply water temperature as measured by the boiler supply sensor. Note: This item is only available when MODE is set to 5.	Factory Installer
BOIL OUT VIEW 180°F	14 to 266°F (-10 to 130°C)	BOILER OUTLET Current boiler outlet water temperature as measured by the boiler outlet sensor. Note: When MODE is set to 5 this item is only visible in the Factory access level.	Factory (Installer for Mode 4)
BOIL IN VIEW 152°F	14 to 266°F (-10 to 130°C)	BOILER INLET Current boiler inlet water temperature as measured by the boiler inlet sensor. Note: This item is only available when a boiler inlet sensor is installed.	Factory Installer
BOIL ΔT VIEW 27°F	0 to 252°F (0 to 140°C)	BOILER DELTA T Current temperature difference between the boiler outlet sensor and the boiler inlet sensor. Note: This item is only available when a boiler inlet sensor is installed.	Factory
BOIL ON VIEW 999	0 to 999	BOILER ON HOURS The total number of running hours of the boiler since this item was last cleared. Clear the numbers of hours by pressing and holding the ▲ and ▼ buttons together while viewing this item.	Factory

After the last item, the control returns to the first item in the menu.

Mode 4 and 5 – Outdoor Reset and Setpoint Operation - Adjust Menu (1 of 3)

Enter Adjust Menu

++

Item ▲ ▼

Next Item

Item

Change Value

▲ ▼

The Program menu items are the programmable settings used to operate the system. **Press and hold all three buttons simultaneously** to enter the Program menu









ADJUST MENU

Item Field	Range	Description	Access	Setting
<div style="border: 1px solid black; padding: 5px; display: flex; justify-content: space-between;"> MODE <div style="text-align: center;"> <small>ADJUST</small> 4 </div> </div>	1 to 8	MODE Select the operating mode for the control.	Factory Installer	Default Setting 4
<div style="border: 1px solid black; padding: 5px; display: flex; justify-content: space-between;"> STG MODE <div style="text-align: center;"> <small>ADJUST</small> P I d </div> </div>	PId or P	STAGE MODE Select the staging operation to be either automatic or manual. (PId = automatic) (P = proportional)	Factory Installer	
<div style="border: 1px solid black; padding: 5px; display: flex; justify-content: space-between;"> BOIL TARGET <div style="text-align: center;"> <small>ADJUST</small> 180^{°F} </div> </div>	OFF, 70 to 220°F (21 to 104°C)	BOILER TARGET Select the boiler target temperature while a setpoint demand is present.	Factory Installer	
<div style="border: 1px solid black; padding: 5px; display: flex; justify-content: space-between;"> OUTDR START <div style="text-align: center;"> <small>ADJUST</small> 70^{°F} </div> </div>	35 to 85°F (2 to 29°C)	OUTDOOR START Select the outdoor starting temperature used in the reset ratio for the heating system. Typically set to the desired building temperature.	Factory Installer	
<div style="border: 1px solid black; padding: 5px; display: flex; justify-content: space-between;"> OUTDR DSGN <div style="text-align: center;"> <small>ADJUST</small> 10^{°F} </div> </div>	-60 to 32°F (-51 to 0°C)	OUTDOOR DESIGN Select the outdoor design temperature used in the reset ratio for the heating system. Set to the coldest annual outdoor temperature in the local area.	Factory Installer	
<div style="border: 1px solid black; padding: 5px; display: flex; justify-content: space-between;"> BOIL START <div style="text-align: center;"> <small>ADJUST</small> 70^{°F} </div> </div>	35 to 150°F (2 to 66°C)	BOILER START Select the starting water temperature used in the reset ratio calculation for the heating system. Typically set to the desired building temperature.	Factory Installer	
<div style="border: 1px solid black; padding: 5px; display: flex; justify-content: space-between;"> BOIL DSGN <div style="text-align: center;"> <small>ADJUST</small> 180^{°F} </div> </div>	70 to 220°F (21 to 104°C)	BOILER DESIGN Select the boiler design water temperature used in the reset ratio calculation for the heating system. Set to the boiler water temperature required to heat the building on the coldest annual outdoor temperature.	Factory Installer	
<div style="border: 1px solid black; padding: 5px; display: flex; justify-content: space-between;"> BOIL OUT MAX <div style="text-align: center;"> <small>ADJUST</small> 200^{°F} </div> </div>	120 to 225°F (49 to 107°C)	BOILER OUTLET MAXIMUM Select the maximum boiler outlet temperature. Exceeding this temperature shuts off the boiler.	Factory	

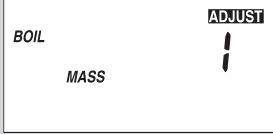
Continued on next page.

Mode 4 and 5 – Outdoor Reset and Setpoint Operation - Adjust Menu (2 of 3)





ADJUST MENU

Item Field	Range	Description	Access	Setting
 <p>BOILER MAX 180°F</p>	120 to 225°F (49 to 107°C), OFF	BOILER MAXIMUM Select the maximum boiler target temperature.	Factory	
 <p>BOILER MIN 140°F</p>	OFF, 80 to 180°F (27 to 82°C)	BOILER MINIMUM Select the minimum boiler target temperature.	Factory	
 <p>DLY 0:10 min</p>	0:00 to 3:00 min (1 second increments)	FIRE DELAY Select the amount of time required for combustion pre-purging, ignition and the flame to be established. Note: This setting is only available when STAGE MODE is set to Pld.	Factory	NOT VALID FOR ELECTRIC BOILER APPLICATION
 <p>BOILER MASS 1</p>	1 (Lo) or 2 (Med) or 3 (Hi)	BOILER MASS Select the thermal mass of the boiler. Note: This setting is only available when STAGE MODE is set to Pld.	Factory Installer	
 <p>STG DLY Au</p>	Au, 0:30 to 9:55 min	STAGE DELAY Select the minimum time delay between stages. Note: This setting is only available when STAGE MODE is set to Pld.	Factory Installer	
 <p>DIFF Au</p>	Au, 2 to 42°F (1 to 23°C)	DIFFERENTIAL Select the boiler differential. Note: The automatic setting is only available when STAGE MODE is set to Pld staging.	Factory	
 <p>DIFF STG 4°F</p>	0 to 10°F (0 to 6°C)	STAGE DIFFERENTIAL Select the interstage temperature differential between stages for proportional staging. Note: This setting is only available when STAGE MODE is set to P.	Factory	
 <p>ON DLY 1:00 min</p>	0:10 to 8:00 min	INTERSTAGE ON DELAY Select the amount of time that must pass once a stage has been turned on in order to allow the next stage to turn on. Note: This setting is only available when STAGE MODE is set to P.	Factory	
 <p>OFF DLY 0:30 min</p>	0:10 to 4:00 min	INTERSTAGE OFF DELAY Select the amount of time that must pass once a stage has been turned off in order to allow the next stage to turn off. Note: This setting is only available when STAGE MODE is set to P.	Factory	

Continued on next page.

Mode 4 and 5 – Outdoor Reset and Setpoint Operation - Adjust Menu (3 of 3)

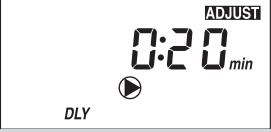
ADJUST MENU

Item Field	Range	Description	Access	Setting
	0:10 to 5:00 min	MINIMUM ON TIME Select the minimum amount of time that the stage contact must remain on before it is allowed to turn off. Note: This setting is only available when STAGE MODE is set to P.	Factory	
	0:10 to 5:00 min	MINIMUM OFF TIME Select the minimum amount of time that the stage contact must remain off before it is allowed to turn back on. Note: This setting is only available when STAGE MODE is set to P.	Factory	
	OFF, 0:20 to 9:55 min, On	PUMP DELAY Select the boiler pump purge time after shutting off the boiler.	Factory	
	35 to 100°F (2 to 38°C), OFF	WARM WEATHER SHUT DOWN Select the heating system warm weather shut down for outdoor reset operation. Heat demands are ignored once the outdoor air temperature exceeds this setting.	Factory Installer	
	°F or °C			Default Setting 65°F

After the last item, the control returns to the first item in the menu.

Mode 6 and 7 – External Target Temperature Input and Setpoint Operation

Applications

Mode 6 – External Target Temperature Input and Setpoint with Parallel Piping

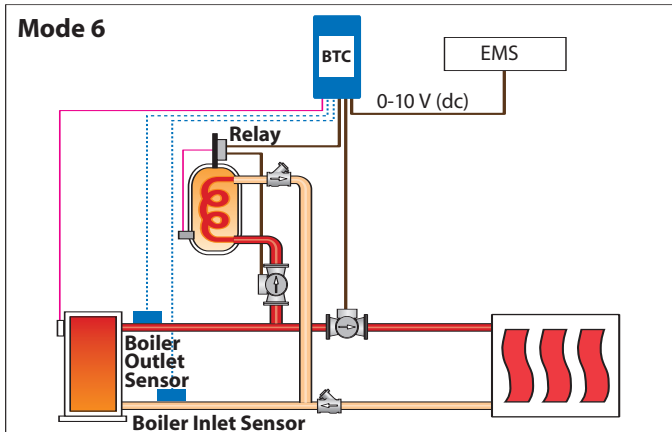

The control receives a heat demand provided from an external target temperature input signal. The control turns on the boiler pump and operates the boiler to maintain the target temperature at the boiler outlet sensor. The control receives a setpoint demand from a DHW aquastat. The control turns on the boiler pump and operates the boiler to maintain the setpoint boiler target temperature at the boiler outlet sensor whenever a setpoint demand is present.

Note: An external relay is required to operate the DHW pump and provide DHW priority if required by disabling the boiler pump.

Mode 7 – External Target Temperature Input and Setpoint with Primary – Secondary Piping

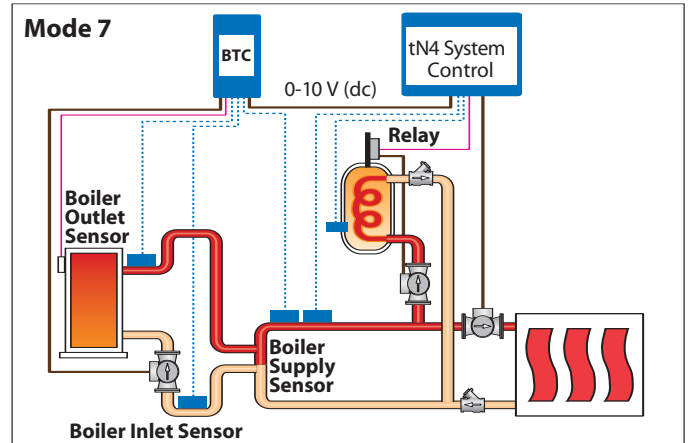

The control receives a heat demand provided from an external target temperature input signal. The control turns on the boiler pump and operates the boiler to maintain the target temperature at the boiler supply sensor. The control receives a setpoint demand from an external control. The control turns on the boiler pump and operates the boiler to maintain the setpoint boiler target temperature at the boiler supply sensor whenever a setpoint demand is present.

Mode 6 and 7 – External Target Temperature Input and Setpoint Operation - View Menu

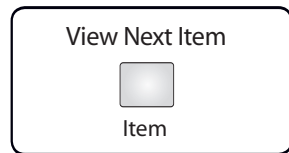

The View menu items display current operating temperatures and system status information. Use the Item button to view items in this menu.

VIEW MENU

Item Field	Range	Description	Access
	---, 35 to 266°F (2 to 130°C), OFF	BOILER TARGET The boiler target is the temperature the control is currently trying to maintain at the boiler supply sensor or the boiler outlet sensor.	Factory Installer
	14 to 266°F (-10 to 130°C)	BOILER SUPPLY Current boiler supply water temperature as measured by the boiler supply sensor. Note: This item is only available when MODE is set to 7.	Factory Installer
	14 to 266°F (-10 to 130°C)	BOILER OUTLET Current boiler outlet water temperature as measured by the boiler outlet sensor. Note: When MODE is set to 7 this item is only visible in the Factory access level.	Factory <i>(Installer for Mode 6)</i>
	14 to 266°F (-10 to 130°C)	BOILER INLET Current boiler inlet water temperature as measured by the boiler inlet sensor. Note: This item is only available when a boiler inlet sensor is installed.	Factory Installer
	0 to 252°F (0 to 140°C)	BOILER DELTA T Current temperature difference between the boiler outlet sensor and the boiler inlet sensor. Note: This item is only available when a boiler inlet sensor is installed.	Factory
	0 to 999	BOILER ON HOURS The total number of running hours of the boiler since this item was last cleared. Clear the numbers of hours by pressing and holding the ? and ? buttons together while viewing this item.	Factory

After the last item, the control returns to the first item in the menu.

Mode 6 and 7 – External Target Temperature Input and Setpoint Operation - Adjust Menu (1 of 2)

Enter Adjust Menu

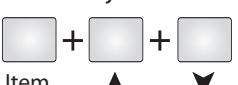

Item ▲ ▼

Next Item



Item

Change Value



▲ ▼

The Program menu items are the programmable settings used to operate the system. **Press and hold all three buttons simultaneously** to enter the Program menu.







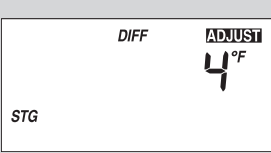

ADJUST MENU

Item Field	Range	Description	Access	Setting
<div style="border: 1px solid gray; padding: 5px;"> <p style="text-align: right; font-size: small;">ADJUST</p> <p style="text-align: center; font-size: 2em;">4</p> <p style="font-size: small;">MODE</p> </div>	1 to 8	<p>MODE</p> <p>Select the operating mode for the control.</p>	Factory Installer	Default Setting 4
<div style="border: 1px solid gray; padding: 5px;"> <p style="text-align: right; font-size: small;">ADJUST</p> <p style="text-align: center; font-size: 2em;">Pld</p> <p style="font-size: small;">STG MODE</p> </div>	Pld or P	<p>STAGE MODE</p> <p>Select the staging operation to be either automatic or manual. (Pld = automatic) (P = proportional)</p>	Factory Installer	
<div style="border: 1px solid gray; padding: 5px;"> <p style="text-align: right; font-size: small;">ADJUST</p> <p style="text-align: center; font-size: 2em;">180°F</p> <p style="font-size: small;">BOIL TARGET</p> </div>	OFF, 70 to 220°F (21 to 104°C)	<p>BOILER TARGET</p> <p>Select the boiler target temperature while a setpoint demand is present.</p>	Factory Installer	
<div style="border: 1px solid gray; padding: 5px;"> <p style="text-align: right; font-size: small;">ADJUST</p> <p style="text-align: center; font-size: 2em;">200°F</p> <p style="font-size: small;">BOIL OUT MAX</p> </div>	120 to 225°F (49 to 107°C)	<p>BOILER OUTLET MAXIMUM</p> <p>Select the maximum boiler outlet temperature. Exceeding this temperature shuts off the boiler.</p>	Factory	
<div style="border: 1px solid gray; padding: 5px;"> <p style="text-align: right; font-size: small;">ADJUST</p> <p style="text-align: center; font-size: 2em;">180°F</p> <p style="font-size: small;">BOIL MAX</p> </div>	120 to 225°F (49 to 107°C), OFF	<p>BOILER MAXIMUM</p> <p>Select the maximum boiler target temperature.</p>	Factory	
<div style="border: 1px solid gray; padding: 5px;"> <p style="text-align: right; font-size: small;">ADJUST</p> <p style="text-align: center; font-size: 2em;">140°F</p> <p style="font-size: small;">BOIL MIN</p> </div>	OFF, 80 to 180°F (27 to 82°C)	<p>BOILER MINIMUM</p> <p>Select the minimum boiler target temperature.</p>	Factory	
<div style="border: 1px solid gray; padding: 5px;"> <p style="text-align: right; font-size: small;">ADJUST</p> <p style="text-align: center; font-size: 2em;">0:10^{min}</p> <p style="font-size: small;">DLY</p> </div>	0:00 to 3:00 min (1 second increments)	<p>FIRE DELAY</p> <p>Select the amount of time required for combustion pre-purging, ignition and the flame to be established. Note: This setting is only available when STAGE MODE is set to Pld.</p>	Factory	NOT VALID FOR ELECTRIC BOILER APPLICATION
<div style="border: 1px solid gray; padding: 5px;"> <p style="text-align: right; font-size: small;">ADJUST</p> <p style="text-align: center; font-size: 2em;">1</p> <p style="font-size: small;">BOIL MASS</p> </div>	1 (Lo) or 2 (Med) or 3 (Hi)	<p>BOILER MASS</p> <p>Select the thermal mass of the boiler. Note: This setting is only available when STAGE MODE is set to Pld.</p>	Factory Installer	
<div style="border: 1px solid gray; padding: 5px;"> <p style="text-align: right; font-size: small;">ADJUST</p> <p style="text-align: center; font-size: 2em;">Au</p> <p style="font-size: small;">STG DLY</p> </div>	Au, 0:30 to 9:55 min	<p>STAGE DELAY</p> <p>Select the minimum time delay between stages. Note: This setting is only available when STAGE MODE is set to Pld.</p>	Factory Installer	
<div style="border: 1px solid gray; padding: 5px;"> <p style="text-align: right; font-size: small;">ADJUST</p> <p style="text-align: center; font-size: 2em;">Au</p> <p style="font-size: small;">DIFF</p> </div>	Au, 2 to 42°F (1 to 23°C)	<p>DIFFERENTIAL</p> <p>Select the boiler differential. Note: The automatic setting is only available when STAGE MODE is set to Pld staging.</p>	Factory	

Continued on next page.

Mode 6 and 7 – External Target Temperature Input and Setpoint Operation - Adjust Menu (2 of 2)

ADJUST MENU

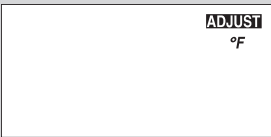
Item Field	Range	Description	Access	Setting
	0 to 10°F (0 to 6°C)	STAGE DIFFERENTIAL Select the interstage temperature differential between stages for proportional staging. Note: This setting is only available when STAGE MODE is set to P.	Factory	
	0:10 to 8:00 min	INTERSTAGE ON DELAY Select the amount of time that must pass once a stage has been turned on in order to allow the next stage to turn on. Note: This setting is only available when STAGE MODE is set to P.	Factory	
	0:10 to 4:00 min	INTERSTAGE OFF DELAY Select the amount of time that must pass once a stage has been turned off in order to allow the next stage to turn off. Note: This setting is only available when STAGE MODE is set to P.	Factory	
	0:10 to 5:00 min	MINIMUM ON TIME Select the minimum amount of time that the stage contact must remain on before it is allowed to turn off. Note: This setting is only available when STAGE MODE is set to P.	Factory	
	0:10 to 5:00 min	MINIMUM OFF TIME Select the minimum amount of time that the stage contact must remain off before it is allowed to turn back on. Note: This setting is only available when STAGE MODE is set to P.	Factory	
	OFF, 0:20 to 9:55 min, On	PUMP DELAY Select the boiler pump purge time after shutting off the boiler.	Factory	
	0:10 or 2:10	EXTERNAL INPUT SIGNAL Select the range of the external input signal.	Factory	
	-10 to +10°F (-6 to +6°C)	OFFSET Select the amount of offset when the boiler target is determined from an external input signal.	Factory	
	°F or °C	TEMPERATURE UNITS Select to display temperature in degrees Fahrenheit or in degrees Celsius.	Factory Installer	

After the last item, the control returns to the first item in the menu.

Mode 8 – External Direct Drive Operation

Application

Mode 8 – External Direct Drive Operation

The control receives a heat demand provided via an external analog input signal from a tekmar sequencing control (such as a 275). The control turns on the boiler pump and the Stage 1, 2, 3 and 4 contacts according to the external input signal.

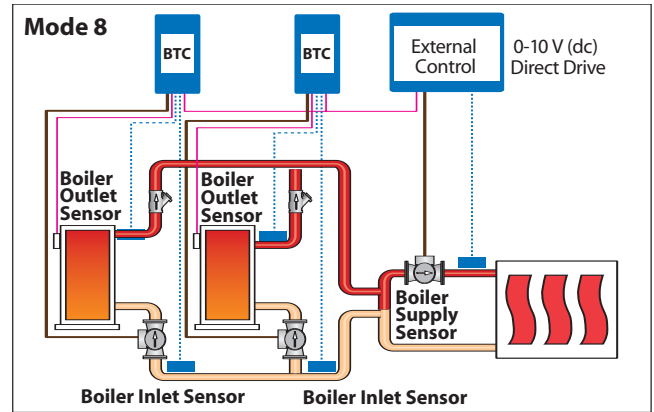

Mode 8 – External Direct Drive Operation - View Menu

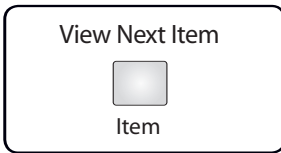

The View menu items display current operating temperatures and system status information. Use the Item button to view items in this menu.

VIEW MENU

Item Field	Range	Description	Access
<div style="border: 1px solid black; padding: 5px;"> BOIL OUT VIEW 180 °F </div>	14 to 266°F (-10 to 130°C)	BOILER OUTLET Current boiler outlet water temperature as measured by the boiler outlet sensor.	Factory Installer
<div style="border: 1px solid black; padding: 5px;"> BOIL IN VIEW 152 °F </div>	14 to 266°F (-10 to 130°C)	BOILER INLET Current boiler inlet water temperature as measured by the boiler inlet sensor. Note: This item is only available when a boiler inlet sensor is installed.	Factory Installer
<div style="border: 1px solid black; padding: 5px;"> BOIL VIEW ΔT 27 °F </div>	0 to 252°F (0 to 140°C)	BOILER DELTA T Current temperature difference between the boiler outlet sensor and the boiler inlet sensor. Note: This item is only available when a boiler inlet sensor is installed.	Factory
<div style="border: 1px solid black; padding: 5px;"> BOIL VIEW 999 ON </div>	0 to 999	BOILER ON HOURS The total number of running hours of the boiler since this item was last cleared. Clear the numbers of hours by pressing and holding the ? and ? buttons together while viewing this item.	Factory

• After the last item, the control returns to the first item in the menu.

Mode 8 – External DirectDrive Operation - Adjust Menu

Enter Adjust Menu

Item + + -

Next Item

Item

Change Value

Item





The Program menu items are the programmable settings used to operate the system. **Press and hold all three buttons simultaneously** to enter the Program menu.

ADJUST MENU

Item Field	Range	Description	Access	Setting
<p>MODE</p>	1 to 8	MODE Select the operating mode for the control.	Factory Installer	Default Setting 4
<p>BOILER OUT MAX</p>	120 to 225°F (49 to 107°C)	BOILER OUTLET MAXIMUM Select the maximum boiler outlet temperature. Exceeding this temperature shuts off the burners.	Factory	
<p>DLY</p>	OFF, 0:20 to 9:55 min, On	PUMP DELAY Select the boiler pump purge time after shutting off the burner.	Factory	
<p>°F</p>	°F or °C	TEMPERATURE UNITS Select to display temperature in degrees Fahrenheit or in degrees Celsius.	Factory Installer	

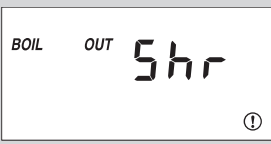
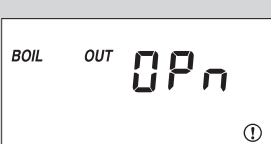
After the last item, the control returns to the first item in the menu.

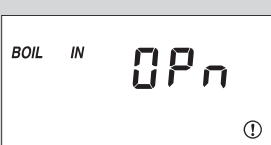
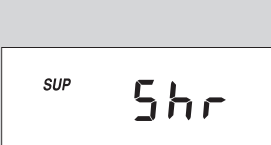
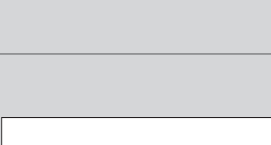
Error Messages (1 of 2)

	<p>E01 The control was unable to read a piece of information from its EEPROM memory. The control will stop operation until all settings in the Adjust menu have been checked by the user or installer. To clear the error message, set Access Level DIP Switch A to Factory (on position), then check all Adjust menu items.</p>
	<p>BOILER OUTLET SENSOR SHORT CIRCUIT The control is no longer able to read the boiler outlet sensor due to a short circuit. In this case, if the boiler inlet sensor is present and operational, the control will operate using the boiler inlet sensor. Otherwise, the control will not operate the boiler. Test the boiler outlet sensor and related wiring. The error message will clear once the error condition is corrected and a button is pressed.</p>
	<p>BOILER OUTLET SENSOR OPEN CIRCUIT The control is no longer able to read the boiler outlet sensor due to an open circuit. In this case, if the boiler inlet sensor is present and operational, the control will operate using the boiler inlet sensor. Otherwise, the control will not operate the boiler. Test the boiler outlet sensor and related wiring. The error message will clear once the error condition is corrected and a button is pressed.</p>
	<p>BOILER INLET SENSOR SHORT CIRCUIT The control is no longer able to read the boiler inlet sensor due to a short circuit. In this case, the control will continue operation. Test the boiler inlet sensor and related wiring. The error message will clear once the error condition is corrected and a button is pressed.</p>
	<p>BOILER INLET SENSOR OPEN CIRCUIT The control is no longer able to read the boiler inlet sensor due to an open circuit. In this case, the control will continue operation. Test the boiler inlet sensor and related wiring. The error message will clear once the error condition is corrected and a button is pressed.</p>
	<p>BOILER SUPPLY SENSOR SHORT CIRCUIT The control is no longer able to read the boiler supply sensor due to a short circuit. In this case, if the boiler outlet sensor is operational, the control will operate based on the boiler outlet sensor. If the boiler outlet sensor is not available and the boiler inlet sensor is present and operational, the control will operate using the boiler inlet sensor. Otherwise, the control will not operate the boiler. Test the boiler supply sensor and related wiring. The error message will clear once the error condition is corrected and a button is pressed.</p>
	<p>BOILER SUPPLY SENSOR OPEN CIRCUIT The control is no longer able to read the boiler supply sensor due to an open circuit. In this case, if the boiler outlet sensor is operational, the control will operate based on the boiler outlet sensor. If the boiler outlet sensor is not available and the boiler inlet sensor is present and operational, the control will operate using the boiler inlet sensor. Otherwise, the control will not operate the boiler. Test the boiler supply sensor and related wiring. The error message will clear once the error condition is corrected and a button is pressed.</p>
	<p>OUTDOOR SENSOR SHORT CIRCUIT The control is no longer able to read the outdoor sensor due to a short circuit. In this case the control assumes an outdoor temperature of 32°F (0°C) and continues operation. Test the outdoor sensor and related wiring. The error message will clear once the error condition is corrected and a button is pressed.</p>

Error Messages (2 of 2)

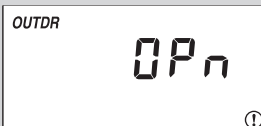
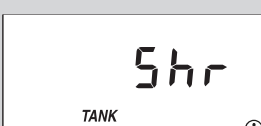
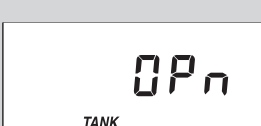
 <p>OUTDR OPn ①</p>	<p>OUTDOOR SENSOR OPEN CIRCUIT</p> <p>The control is no longer able to read the outdoor sensor due to an open circuit. In this case the control assumes an outdoor temperature of 32°F (0°C) and continues operation.</p> <p>Test the outdoor sensor and related wiring. The error message will clear once the error condition is corrected and a button is pressed.</p>
 <p>TANK Shr ①</p>	<p>DHW TANK SENSOR SHORT CIRCUIT</p> <p>The control is no longer able to read the DHW tank sensor due to a short circuit. In this case, the control will not operate the boiler.</p> <p>Test the DHW tank sensor and related wiring. The error message will clear once the error condition is corrected and a button is pressed.</p>
 <p>TANK OPn ①</p>	<p>DHW TANK SENSOR OPEN CIRCUIT</p> <p>The control is no longer able to read the DHW tank sensor due to an open circuit. In this case, the control will not operate the boiler.</p> <p>Test the DHW tank sensor and related wiring. The error message will clear once the error condition is corrected and a button is pressed.</p>

RELOAD FACTORY DEFAULTS

To reload **FACTORY DEFAULT SETTINGS**, press and hold the outside buttons (Item and Down) while powering the control up. This will reload the **FACTORY DEFAULTS**.

Technical Data

EM-10 (Monitron II) Electric Boiler Temperature Control

Packaged weight	— 0.38 lb. (170 g)
	— Enclosure D, black noryl plastic
Dimensions	— 4-3/4" H x 2-7/8" W x 1-7/8" D (120 x 74 x 48 mm)
Approvals	— ANSI Z21.23, CAN 1-6.6-M78-R2001, UL873, UL840
Ambient conditions	— Indoor use only, -40 to 140°F (-40 to 60°C), < 90% RH non-condensing
Power supply	— 24 V (ac) ±10% 50/60 Hz 75 VA
Pump / Stage 1 Relays	— 120 V (ac) 5 A 1/6 hp pilot duty 240 VA
Stage 2, 3, 4 Relays	— 120 V (ac) 3 A 1/6 hp pilot duty 240 VA
Demands	— 24 to 120 V (ac) 2 VA
Sensors	— NTC thermistor, 10 k Ω @ 77°F (25°C ±0.2°C) β =3892
included:	— 1 of Universal Sensor 071 with 96" long wires (S/F P/N 790400000) Outdoor Sensor 070 (S/F P/N 339070000)
optional:	— Universal Sensor 071

